

MD720UIS All-in-One PTZ Camera

— **User Manual** —

How to Clean and Disinfect

Warning Risk of personal injury	Do not use cleaning agents containing phenol. Phenol may cause skin burns if not rinsed thoroughly and does not contain sufficient cleaning or disinfectant properties.
Caution	<ol style="list-style-type: none">1. The camera is designed for easy cleaning and disinfection.2. Before cleaning the camera, disconnect it from the power source.3. Cleaning procedures should only be carried out by personnel familiar with camera operation.4. Do not spray cleaning fluid, especially water, into any internal electrical equipment or parts of the camera to avoid possible short circuits, corrosion, malfunction and electrical shock hazards to users or service personnel.5. Corrosive cleaning agents may cause discoloration or damage the camera. Before using any cleaning agent, test it in an inconspicuous area.
When	Clean the camera before and after use.
Steps	<ol style="list-style-type: none">1. Disconnect the camera from a power source.2. Cleaning personnel must wear cleaning gloves.3. Before using cleaning alcohol, make sure it has not expired.4. Use a cleaning cloth dampened with cleaning alcohol (75%).5. Wipe any surface that may come into contact with the camera.6. After wiping the camera, avoid contact with bare hands.
Frequency	No regular cleaning is required. Clean before and after use.

Precautions for Use

AVer does not accept any responsibility for accident or damage during installation if users do not follow the procedures described in this manual.

The AVer MD720UIS Tracking Camera is a high definition medical grade camera designed for physicians and caregivers, and suitable for use in a hospital examination room, patient monitoring and similar medical environments. This non-contact device can be operated by physicians and caregivers without physical contact with patients, to document and update patients' injuries by taking snapshots or record videos.

To installation and operation personnel

The required information including the device's hardware parts, operations and important notice has been written and illustrated in this manual. Except for the information in this manual, no special skills, training and knowledge are required for the operators. Read the user manual thoroughly and operate the device correctly and safely. For common issues, please refer to the <Troubleshooting> chapter. For further assistance, please contact AVer technical support.

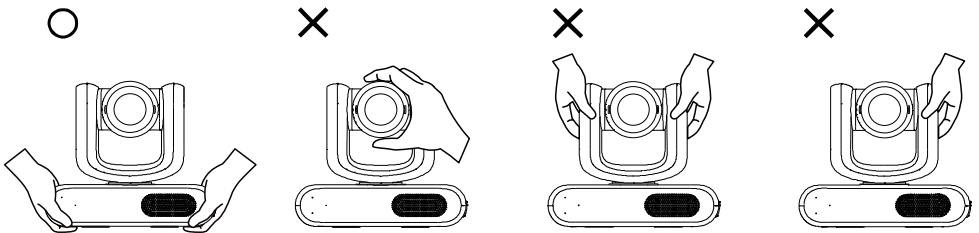

● Transportation

- Hold the bottom of the device with both hands. Do not grab the lens or the lens holder.
- When transporting the device, package it in its original box.

● Operating conditions

This device is for indoor use only. Do not install or use the device in the following conditions to avoid malfunction or damage.

- Do not exposed to direct sunlight.
- Do not exposed to rain or water.
- Do not exposed to extreme temperatures. Recommended operating temperatures: 0°C to +35°C; humidity: 20% to 80%.
- Do not install the device sideways on a wall.
- At sea, in coastal areas or in locations where corrosive gases are emitted.
- Locations subject to strong vibrations. This unit is not suitable for use in vehicles or on carts travelling on uneven surfaces.

● To ensure the device perform stably over a prolonged period

- Do not use this unit in a location with high temperature and humidity levels, which may cause its parts to deteriorate and shorten its service life.
- Do not subject the device to sudden changes in temperature. Keep a cooling unit or heating unit away from this unit.
- Do not leave the device with the camera facing the sun.

● **Operation instructions**

- Make sure the cables behind the device are untangled before powering on the device.
- Use the device with care. Do not operate the device beyond its design limits to avoid damage.
- Do not connect the lens cable to computers, USB ports, or USB extension cables as doing so will damage the device. The lens cable is not a standard USB cable.
- Make sure the lens cable installed behind the lens is untangled before powering on the device.
- Use the device with care. Do not operate the device beyond its designed limits to avoid damage.

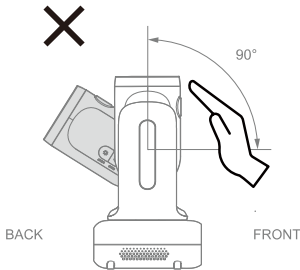

● **Always use the supplied power adapter and power cord to connect the device to a power outlet**

- Before installation, make sure to disconnect the device from a power outlet.
- Install the device near the power outlet to make sure the power plug can be plugged and unplugged from the power outlet easily.
- To avoid electric arc from damaging other electrical components, connect the power cord to the DC 12V power jack on the device before connecting to a power outlet.
- The length of the power cord should be less than 3 m.
- Do not place the device where the cord can be stepped on as this may fray or damage the cord or the plug.

● **Powering off the device**

- The device does not have a power switch. Disconnect the device from a power outlet before maintenance, cleaning or in the event of an emergency.

- **Maintenance**







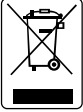

- The device does not have a power switch. Disconnect the device from a power outlet before maintenance.
- Designate personnel to clean the device. Please refer to the <How to Clean and Disinfect> chapter.
- When the device surface is stained, please refer to the <How to Clean and Disinfect> chapter.
- Regular maintenance keeps your device operational and safe. Check all parts, including the lens, camera unit and remote control.

- **Disposal of the device**

- When the device is no longer used, turn off the device and dispose of it properly.
- When disposing of the device or accessories, follow relevant regulations in your country or region and medical facility regarding environmental pollution.

Symbols on this Product

The symbols on this product, including the accessories, represent the following.

	<p>The WEEE symbol. This symbol indicates that this product must not be disposed of with your other household waste. Instead, you need to dispose of the waste equipment by handing it over to a designated collection point for the recycling of waste electrical and electronic equipment. For more information about where to drop off your waste equipment for recycling, please contact your household waste disposal service or the shop where you purchased the product.</p>
	<p>The CE compliance logo. This logo indicates that the product conforms to the relevant guidelines/standards for the European Union harmonization legislation.</p>
	<p>The FCC compliance logo. This logo indicates that the product conforms to Federal Communications Commission compliance standards.</p>
	<p>The UKCA (UK Conformity Assessed) symbol. This symbol indicates that a product placed on the Great Britain market meets the UKCA Marking requirements.</p>
	<p>The RCM compliance logo. This logo indicates that the product conforms with Australian RCM guidelines.</p>
	<p>This logo is intended to alert the users to the presence of un-insulated "dangerous voltage" within the product's enclosure that may be of sufficient magnitude to constitute a risk of electric shock to persons.</p>
	<p>This logo is intended to alert the users to the presence of important operating and maintenance (servicing) instructions in the literature accompanying the appliance.</p>
	<p>The alternating current symbol. This symbol indicates that the power input/output for the product is alternating current.</p>
	<p>The direct current symbol. This symbol indicates that the power input/output for the product is direct current.</p>

FCC Compliance Statement

NOTE: This equipment has been tested and found to comply with the limits for a Class A digital device, pursuant to part 15 of the FCC Rules. These limits are designed to provide reasonable protection against harmful interference when the equipment is operated in a commercial environment. This equipment generates, uses, and can radiate radiofrequency energy and, if not installed and used in accordance with the instruction manual, may cause harmful interference to radio communications. Operation of this equipment in a residential area is likely to cause harmful interference in which case the user will be required to correct the interference at his own expense.

FCC Caution: Any changes or modifications not expressly approved by the party responsible for compliance could void the user's authority to operate this equipment.

This device complies with part 15 of the FCC Rules.

Operation is subject to the following two conditions:

- (1) This device may not cause harmful interference, and
- (2) this device must accept any interference received, including interference that may cause undesired operation.

This Class A digital apparatus complies with Canadian ICES-003.

Cet appareil numérique de la classe A est conforme à la norme NMB-003 du Canada.

Warning

This is a class A product. In a domestic environment this product may cause radio interference in which case the user may be required to take adequate measures.

Caution

Risk of explosion if battery is replaced by an incorrect type. Dispose of used batteries according to the instructions.

PoE

The PoE++ port is connected only to PoE networks without routing to the outside plant.

PSTI Statement of Compliance

Please refer to the following website: <https://www.aver.com/product-security-advisory>

DISCLAIMER

No warranty or representation, either expressed or implied, is made with respect to the contents of this documentation, its quality, performance, merchantability, or fitness for a particular purpose. Information presented in this documentation has been carefully checked for reliability; however, no responsibility is assumed for inaccuracies. The information contained in this documentation is subject to change without notice.

In no event will AVer Information Inc. be liable for direct, indirect, special, incidental, or consequential damages arising out of the use or inability to use this product or documentation, even if advised of the possibility of such damages.

TRADEMARKS

“AVer” is a trademark owned by AVer Information Inc. Other trademarks used herein for description purpose only belong to each of their companies.

COPYRIGHT

©2024 AVer Information Inc. All rights reserved. | October 9, 2024

All rights of this object belong to AVer Information Inc. Reproduced or transmitted in any form or by any means without the prior written permission of AVer Information Inc. is prohibited. All information or specifications are subject to change without prior notice.

More Help

For FAQs, technical support, software and user manual download, please visit:

Non-USA

Download Center: <https://www.aver.com/download-center>

Technical Support: <https://www.aver.com/technical-support>

USA

Download Center: <https://www.averusa.com/pro-av/support>

Technical Support: <https://averusa.force.com/support/s/contactsupport>

Contact Information

Headquarters

AVer Information Inc.

8F, No.157, Da-An Rd., Tucheng Dist.,

New Taipei City 23673, Taiwan

Tel: +886 (2) 2269 8535

USA Branch Office

AVer Information Inc., Americas

44061 Nobel Drive, Fremont, CA 94538, USA

Tel: +1 (408) 263 3828

Toll-free: +1 (877) 528 7824

Europe Branch Office

AVer Information Europe B.V.

Westblaak 134, 3012 KM, Rotterdam, The

Netherlands

Tel: +31 (0) 10 7600 550

Japan Branch Office

アバー・インフォメーション株式会社

〒160-0023 日本東京都新宿区西新宿 3-2-26 立

花新宿ビル 7 階

Tel: +81 (0) 3 5989 0290

お客様サポートセンター(固定電話のみ): +81 (0) 120
008 382

Vietnam Branch Office

Công ty TNHH AVer Information (Việt Nam)

Tầng 5, 596 Nguyễn Đình Chiểu,

P.3, Quận 3,

Thành phố Hồ Chí Minh 700000, Việt Nam

Tel: +84 (0) 28 22 539 211

Hỗ trợ kỹ thuật: +84 (0) 90 70 080 77

Korea Office

한국 에버 인포메이션 (주)

서울시 종로구 새문안로 92

(신문로 1가, 광화문오피시아빌딩) 1831, 1832 호

Tel: +82 (0) 2 722 8535

Contents

How to Clean and Disinfect	2
Precautions for Use.....	3
Overview	1
Package Contents	1
Optional Accessories	1
Parts Info	2
LED Indicators	3
Privacy Indicator	3
Voice Command Indicator.....	3
Status Indicator	3
Dimensions.....	4
Ceiling Mount.....	5
Wall Mount.....	6
Pan and Tilt Angle.....	7
Remote Control.....	8
Shortcuts.....	9
Installation	10
Cable Fixing Plate.....	10
Device Connection	11
Set up your Camera.....	12
OSD Menu	12
IP Address Setup	12
OSD Menu Tree.....	13
Access the Web Interface.....	15
AVer IPCam Utility.....	15
AVer ViewCare	17
Web Interface.....	18

Live View	18
Camera Control.....	18
Preset	19
AI Setting	20
Eyes Tracking	20
AI Video Detection	21
Camera Settings.....	23
Exposure.....	23
Image Process	24
Layout.....	25
Video & Audio	26
Network	27
System.....	29
Specifications	31
Troubleshooting	34
Appendix	35
Voice Command List.....	35

Overview

The MD720UIS Tracking Camera is a medical grade camera designed for patient monitoring. It features infrared night vision and UV-resistant casing.

Package Contents



Camera

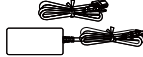

Power Adapter &
Power Cord



Remote Control

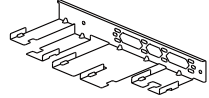

Cable Fixing Plate



Cable Tie (x6)



M2 x 4mm
Screw (x2)



Quick Start Guide

Optional Accessories

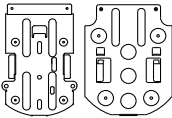

Ceiling Mount
Bracket (x2)

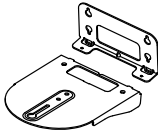

Wall Mount
Bracket

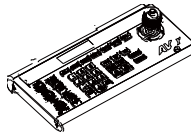

Camera Controller
(CL01)

Parts Info

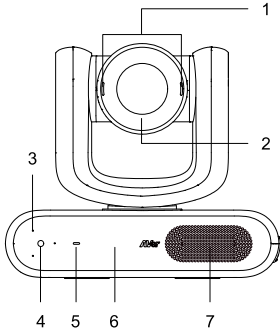

Front View

1. Privacy Indicator
2. Infrared Night Vision LED*
3. Microphone Array**
4. Voice Command Indicator
5. Status Indicator
6. IR Remote Control Sensor
7. Speaker

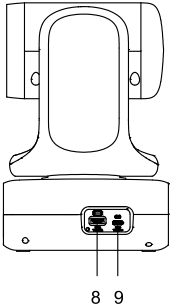

Side View

8. USB 3.0 Type-A Port
9. USB 3.0 Type-C Port

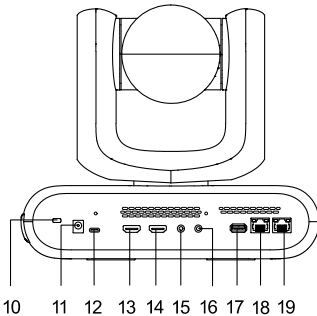

Back View

10. Kensington Lock
11. DC 12V Power Jack
12. USB 3.0 Type-C Port
13. HDMI Out
14. HDMI In
15. Audio In
16. Line Out
17. Wi-Fi Dongle
18. Ethernet Port
19. PoE++ Port

*To avoid infrared radiation hazards, keep a distance of over 1 meter between IR LED and human eyes when using Night Mode.

**Your device supports voice control. For voice command list, please refer to the Appendix <[Voice Command List](#)>.

LED Indicators

Privacy Indicator

Color	Status
Solid purple	Monitoring
No light	Privacy mode / power off

Voice Command Indicator

Color	Status
Solid lake blue	Standby
Slow flashing lake blue	Waiting to receive voice control
Quick flashing lake blue	Perform voice control

Status Indicator

Color	Status
Flashing orange	Initializing
Solid purple	Normal
Solid blue	Standby
Flashing blue	Tracking ON
Solid orange	Privacy mode
Flashing purple	Firmware updating
Flashing red	Insufficient PoE++ power wattage supply
No light	Power off

Dimensions

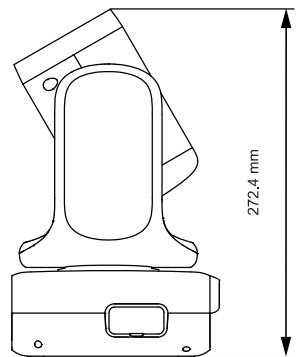
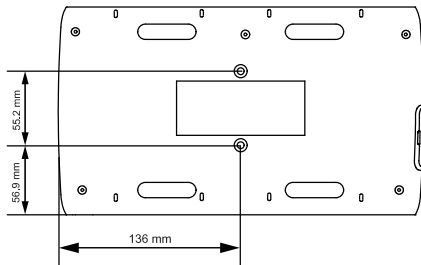
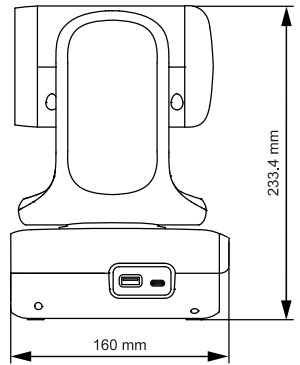
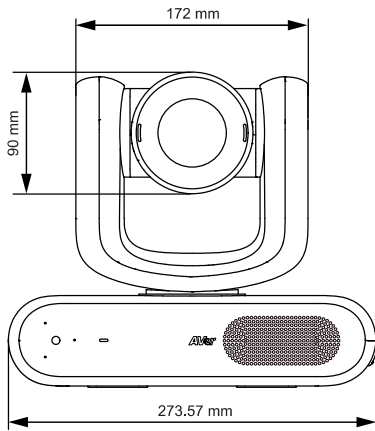

Ceiling Mount

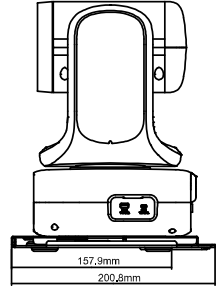
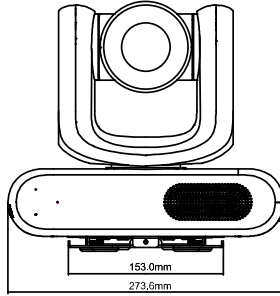
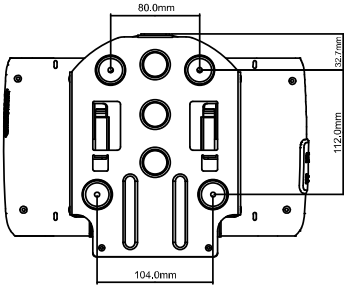
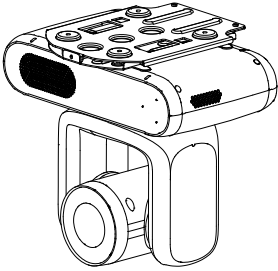

Wall Mount

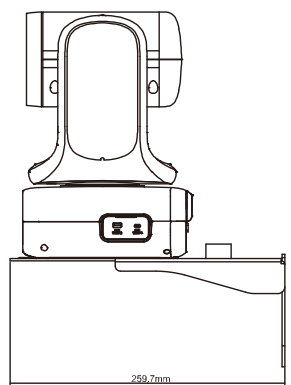
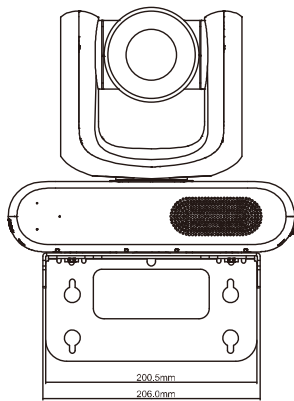
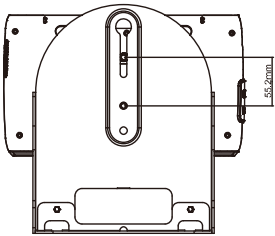
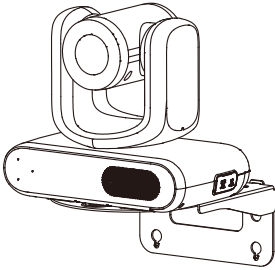

Pan and Tilt Angle

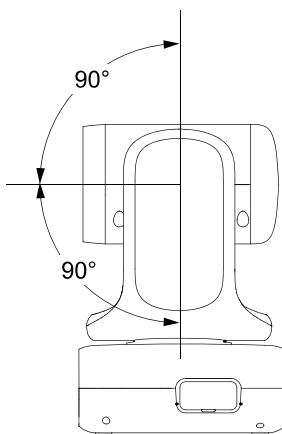
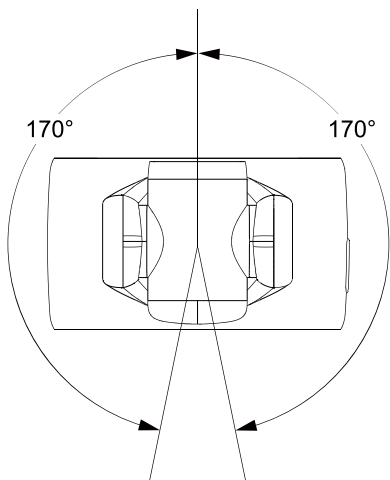

Remote Control



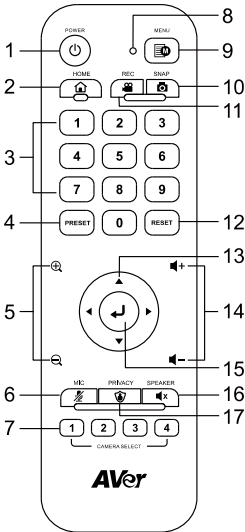



- To open the OSD menu, press and hold the **Menu**  button or 3 seconds.
- To disable the remote control, open the OSD menu or web interface and go to **System > Camera Selector > Disable Remote**.
- To resume the remote control, open the web interface and go to **System > Camera Selector > All Channel** or assign a number (**1, 2, 3, 4**) to your camera.



Model: LY033
AAA batteries (x2)

Name	Function
1. Power	Power on or off.
2. Home	<ul style="list-style-type: none"> • Press to return to the previous page in the Android System Settings in the OSD menu. • Press and hold for 3 seconds to return to the OSD main menu.
3. Number Pad	Press buttons 0-9 to load presets.
4. Preset	To save a preset: <ol style="list-style-type: none"> 1. Position the camera using pan, tilt and zoom controls. 2. Press and hold Preset, then press a number button (0-9) to save that preset.
5. Zoom +/-	Zoom in or out.
6. MIC	Mute or unmute the microphone.
7. Camera Select	Select a camera to operate. Specify a number in the OSD menu: System > Camera Selector .
8. Remote Control LED	When pressing the buttons on the remote control, the LED will light red.
9. Menu	Press and hold for 3 seconds to open the OSD menu. Edit this setting in the OSD menu: System > Trigger OSD .
10. Snap	Press to take a snapshot of the camera live view.
11. Rec	Press to record camera live view.
12. Reset	To clear a preset, press and hold Reset , then press a number button (0-9).
13. Direction	Use the Direction Buttons to navigate the live view.
14. Volume +/-	Adjust the volume.
15. Enter	Autofocus once. Or confirm a selection on the OSD menu.
16. Speaker	Mute or unmute the speaker.
17. Privacy	Enter Privacy Mode. The camera turns downwards and the microphone is muted.

Shortcuts

Press	To
Menu  for 3 seconds	Open the OSD menu.
Menu 	Close the OSD menu.
Home 	Close the OSD menu and return the camera to the Home position.
Menu  then Zoom 	Switch between Day mode and Night mode.
Menu  then Zoom 	Switch between Day mode and Auto mode.
5 five times (55555)	Turn on DHCP.
6 six times (666666)	Reset the camera to factory default settings.
8 eight times (88888888)	Set the camera's static IP address to 192.168.1.168.

Installation

Cable Fixing Plate

1. Secure the cable fixing plate using the included M2 x 4mm screws.
2. Plug in the cables.
3. Secure the cables and the cable fixing plate with cable ties.

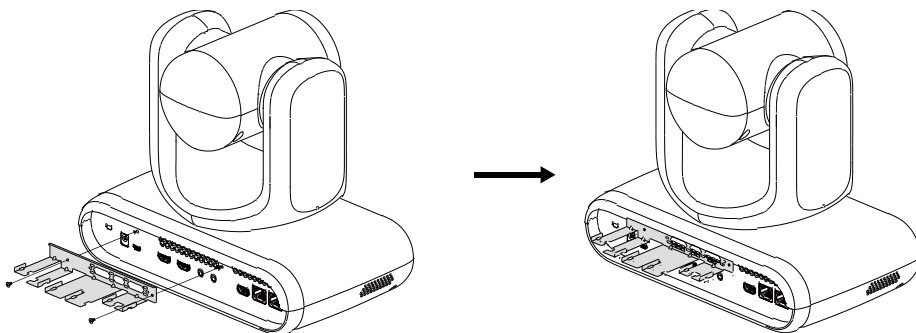

Device Connection

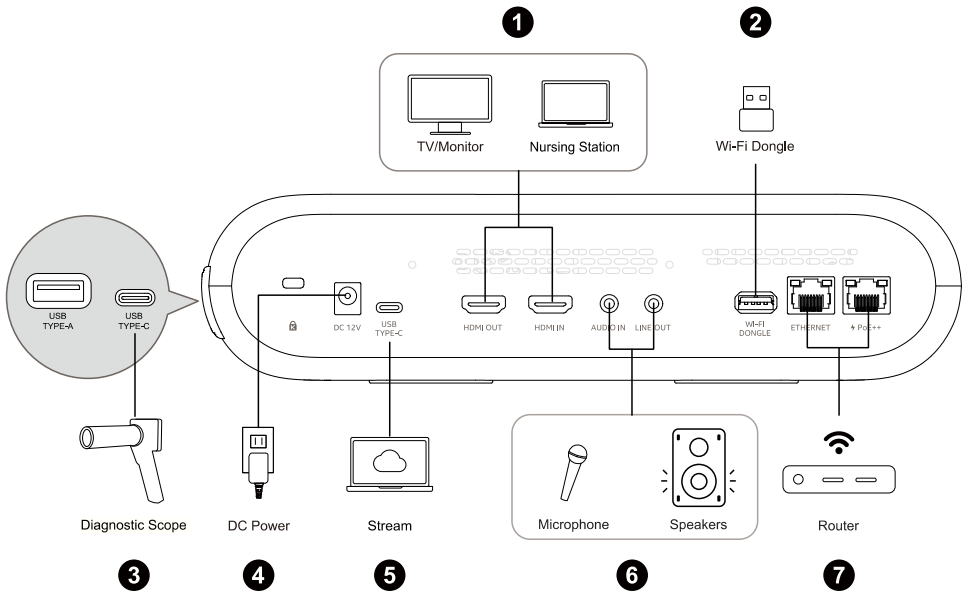

- 1. TV/Monitor & Nursing Station:** Connect the camera to a TV/Monitor or Nursing Station via HDMI Out/In port for HDMI video output.
- 2. Wi-Fi Dongle:** Connect the Wi-Fi Dongle to the camera to receive Wi-Fi signal.
- 3. Diagnostic Scope:** Connect the diagnostic scope to the camera's USB Type-C port on the left side for a closer examine on the patients' body.
- 4. DC Power:** Connect the camera to the power outlet with the supplied power adapter and cable to power on.
- 5. Stream:** Connect the computer to the camera's USB Type-C port on the rear side of the camera for online video streaming.
- 6. Microphone & Speakers:** Connect a microphone or a speaker to the camera's 3.5 mm Audio In/Line Out port for audio input and output.
- 7. Router:** Connect the router or an Ethernet cable to the camera's Ethernet or PoE++ port for Internet connection.

Set up your Camera

Configure camera settings through the OSD menu or the web interface.

OSD Menu

To access the OSD menu, connect the camera to a monitor or TV using an HDMI cable, and then use the supplied remote control to operate the OSD menu.

Press and hold **Menu**  for 3 seconds to open the OSD menu. Use directional buttons **▲▼◀▶** to select and press Enter **↵** to confirm settings.

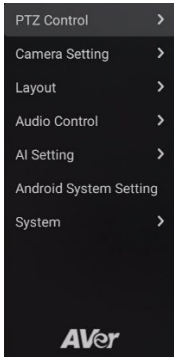

IP Address Setup

1. Press and hold Menu  for 3 seconds on the remote control to open the OSD menu. Go to **Android System Setting > Network & internet > Ethernet > Ethernet IP mode**.
2. Select **Static IP** or **DHCP**. The camera default is DHCP.
3. You may also check the camera IP in **System > Information** of the OSD menu.

OSD Menu Tree

1st level	2nd level	3rd level	4th level
PTZ Control	PTZ Control Panel		
Camera Setting	Exposure Mode	Full Auto	
		Shutter Priority	
		Iris Priority	
		Manual	
	White Balance	Auto	ON / OFF
		ATW	
		Indoor	
		Outdoor	
		One Push	
		Manual	R Gain: 0-255 B Gain: 0-255
	Pan Tilt Zoom	Preset Speed	5 / 25 / 50 / 100 / 150 / 200
		Pan Speed	1-24
		Tilt Speed	1-24
		Zoom Speed	Low / High
		P/T Spd. Relative Z Ratio	ON / OFF
		Pan L/R Dir.Switch	ON / OFF
		Focus Mode	Auto / Manual
		Noise Filter	Off / Low / Middle / High
	Saturation	0-10	
	Contrast	0-4	
Sharpness	0-3		
Mirror	ON / OFF		
Flip	ON / OFF		
Advanced Setting	IR Cut Filter Mode	Day / Night / Auto	
	IR Cut Sensitivity	Low / Middle / High	
	Video Theme Mode		
	AI Mosaic	ON / OFF	
Layout	Single	HDMI in / UVC in / PTZ Camera	
	PIP	Mode 1 / 2 / 3	
	POP	ON / OFF	
Audio Control	Speaker Volume	Up / Down / Mute	
AI Setting	Eyes Tracking	Eyes Tracking	ON / OFF

		Tracking Site	Save
		Tracking Type	Full Face / Eyes
		Tracking Range	Close / Medium / Wide
		Timeout to Site	3 / 5 / 7 / 10 sec
	AI Video Detection	AI Video Detection	ON / OFF
		Detection Type	All Type / Fall / Egress
Android System Setting			
System	Trigger OSD	Click Menu to open, Press Menu 3 sec	
	Camera Select	1 / 2 / 3 / 4 / All Channel / Disable Remote	
	Status OSD	OFF / ON	
	Information		
	Factory Default		
	System Reboot		
	Camera Resume		

Access the Web Interface

To access the MD720UIS web interface, use any of the following software to find its IP address:

- AVer IPCam Utility
- AVer ViewCare

Note: The camera's default network setting is DHCP.

AVer IPCam Utility

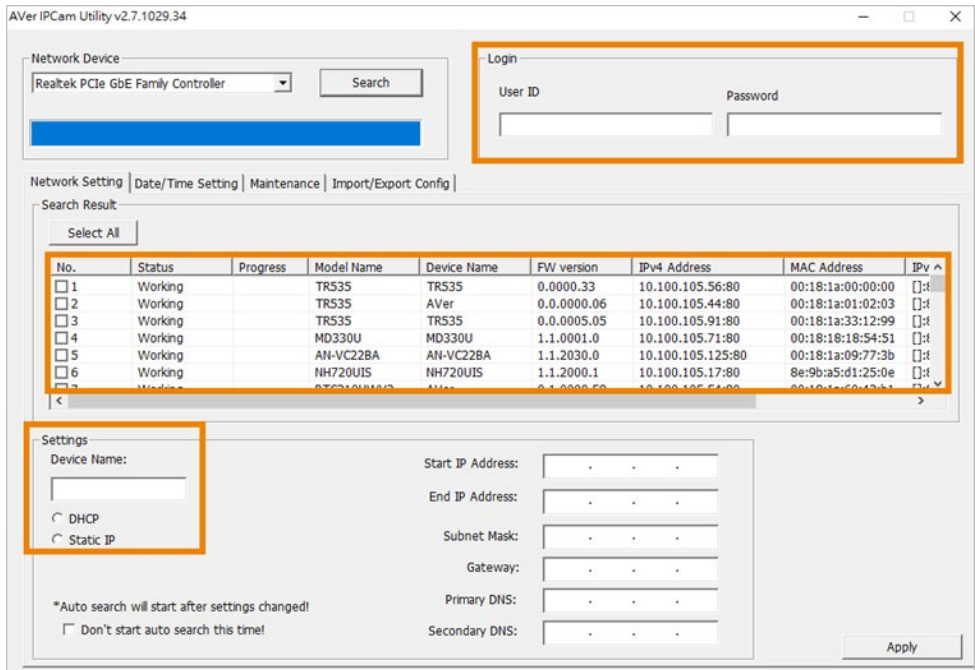

To access the Web interface:

1. Download IPCam Utility from AVer Download Center (<https://www.aver.com/download-center>) and launch the software.
2. Click **Search** to see available devices on the same local area network (LAN).

Notes:

- Make sure your MD720UIS is connected to the internet.
 - The IPCam Utility and your camera must be on the same LAN.
3. Double-click your MD720UIS's IP address in the **IPv4 Address** column to open the web interface in your browser.

When logging in for the first time:

Change the default username and password before logging in.

- **Username:** Use 1-32 characters.
- **Password:** Use 8-32 characters, including uppercase and lowercase letters, numbers, and symbols (%+=, -_ ^/ @.-). The password cannot be the same as the username.

To change the network to DHCP or Static IP:

1. Select the checkbox of your camera.
2. Enter the default or current username and password in the Login field.
3. Select DHCP or Static IP, then enter your network settings if applicable in the Settings section.
4. Click **Apply**.

AVer ViewCare

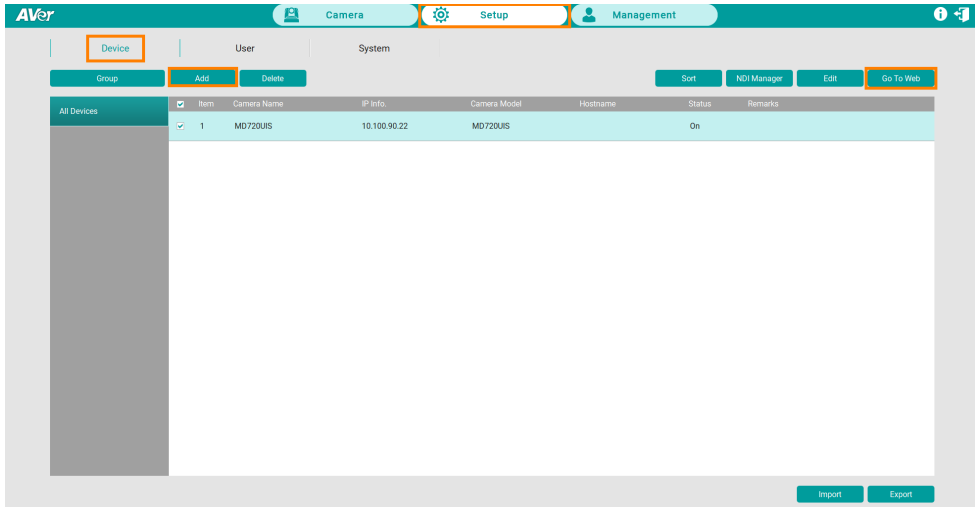

1. Download ViewCare from AVer Download Center (<https://www.aver.com/download-center>) and launch the software.
2. Log in with the ViewCare default username and password **admin/admin**.
3. Go to **Setup > Device > Add**, then click **Auto Search** to see available devices on the same local area network (LAN).
4. Select your camera, enter the current camera username and password, then click **Save** to add the camera to the device list.

Note: For first-time use, enter the default camera username and password **admin/admin**.

5. Select the checkbox of your camera, then click **Go to Web** button to open the web interface in your browser.



Web Interface

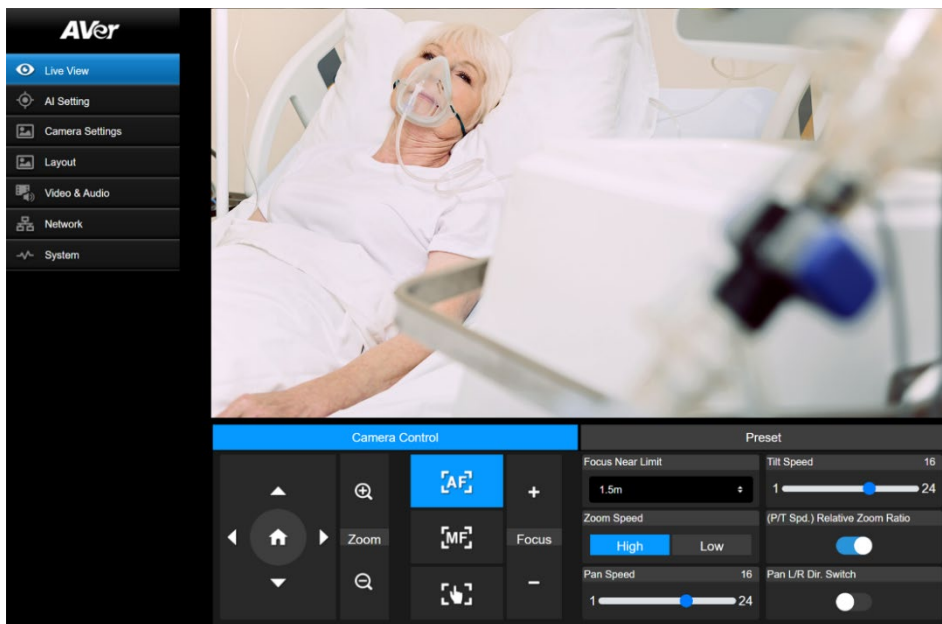

Live View

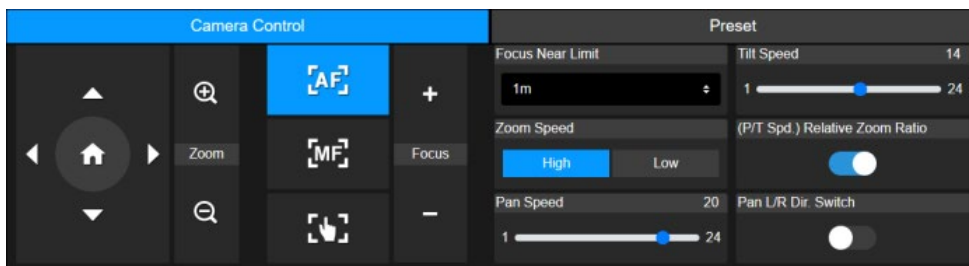

Camera Control



Item	Description
Pan Tilt Zoom Controls	<ul style="list-style-type: none">Position the camera with the directional buttons.Click  to move the camera to the Home position.Click  /  to zoom in and out.

Focus + / -	<ul style="list-style-type: none"> : Automatic focus. : Manual focus. Adjust the focus with + - buttons. : One-Push Focus: Click to automatically focus once.
Focus Near Limit	Set up the nearest focus limit.
Zoom / Pan / Tilt Speed	Select a speed option or drag the slider to adjust the zoom, pan and tilt speed.
(P/T Spd.) Relative Z Ratio	Turn on to automatically adjust pan and tilt speeds based on the zoom ratio. You can also turn it on in the OSD menu: Camera Setting > Pan Tilt Zoom > P/T Spd. Relative Z Ratio.
Pan L/R Dir. Switch	Turn on to invert panning direction.

Preset

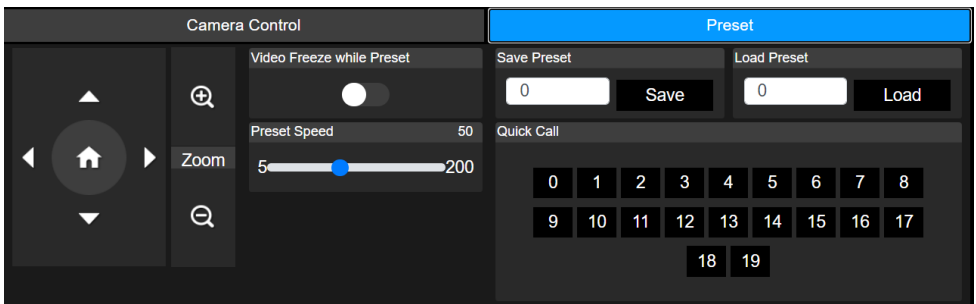

Item	Description
Save Preset	<ol style="list-style-type: none"> Position the camera using pan, tilt and zoom controls. Enter a preset number (0-255) in the textbox and click Save.
Load Preset	<ol style="list-style-type: none"> Enter a preset number (0-255) in the textbox and click Load. Click a preset number (0-19) in the Quick Call section.
Video Freeze while Preset	Turn on to display only the live view from presets. The live view from the moving path will not be displayed.
Preset Speed	Adjust the speed when moving to presets.

AI Setting



Eyes Tracking

Manually adjusting pan, tilt and zoom controls during Facial Tracking will turn off the function.

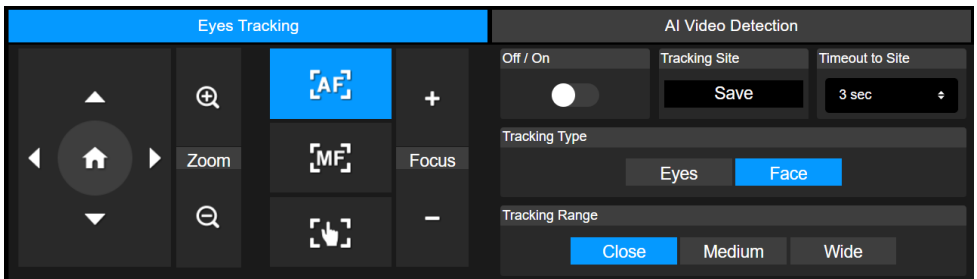

1. Please set up the Tracking Site with camera pan, tilt and zoom controls and then click **Save** to save a **Tracking Site**. The default is the Home position.
2. From the **Timeout to Site** drop-down list, select an interval before the camera returns to the tracking site when no one is on screen. The default is 3 seconds.
3. Select **Tracking Type** and **Tracking Range**.

4. Toggle on eyes tracking.
 - One person: The camera automatically tracks and zooms in on the face.
 - Multiple people: The camera frames all faces in bounding boxes. Click a square to select a face you want to track and zoom in on.

AI Video Detection

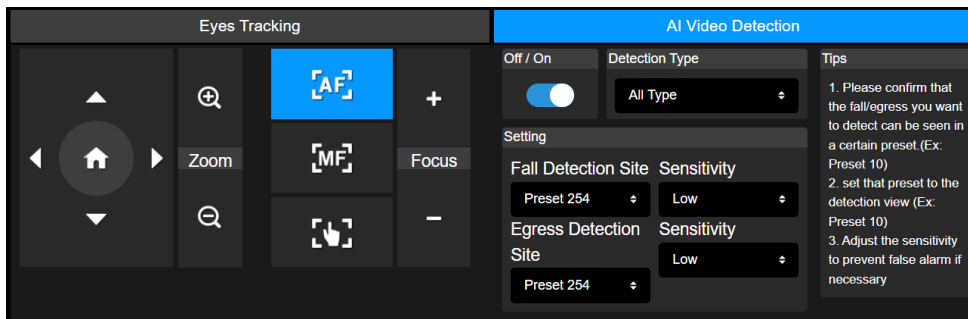

To set up AI video detection:

1. Make sure you have defined the required preset for AI video detection.
2. Set that preset to the detection view (Ex: Preset 10) and adjust the sensitivity to prevent false alarm if necessary.
3. Select a detection type from the drop-down list. (Fall, Egress or all.)
4. Toggle on AI video detection.

DISCLAIMER

Learn about the accuracy and limitations of the fall detection

The fall detection is an advanced technology designed to enhance patient safety in hospital environments.

Limited Accuracy

The ability of the fall detection to accurately identify a fall event was tested in a controlled environment. This does not guarantee the successful identification and alarms for all fall events in real world use. Many factors can affect the performance of the fall detection, such as an obstructed field of view or restricted view angle.

Dose not Replace Caregivers

The fall detection is intended as an assistive tool and must not be used as the replacement for caregivers. Frameworks which mandate periodic checks by a trained professional to ensure patient

safety and which relate to clinical diagnosis, patient care or treatment must remain in place. If fall detection fails to respond as described, take appropriate action immediately.

The fall detection is intended as an assistive tool and is not part of a medical device. It is not a patient monitor and cannot be used to make a medical or clinical decision.

Camera Settings

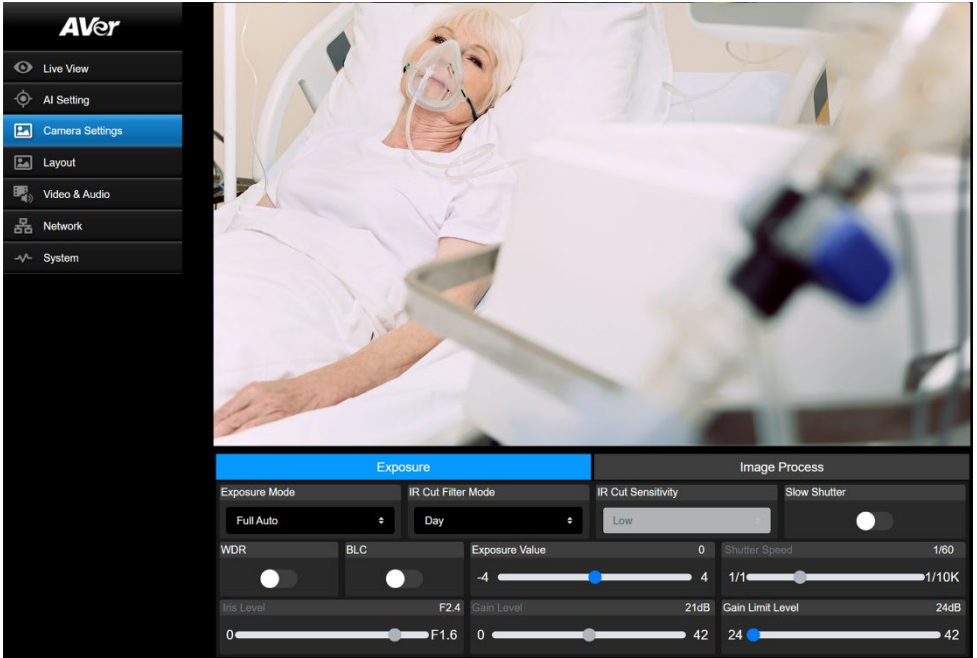

Exposure

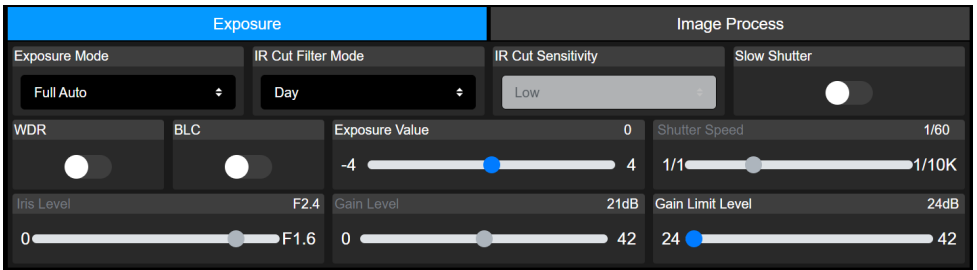

Item	Description
Exposure Mode	Select an exposure mode.
IR Cut Filter Mode	Select Day or Night mode to switch infrared night vision on or off. Select Auto mode and then adjust IR Cut Sensitivity .
IR Cut Sensitivity	Select Auto for IR Cut Filter Mode to adjust IR Cut sensitivity.
Slow Shutter	Turn Slow Shutter on or off.
WDR	Turn WDR or BLC on or off.
BLC	

Exposure Value	Adjust exposure, shutter, iris and gain.
Shutter Speed	
Iris Level	
Gain Level	
Gain Limit Level	

Image Process

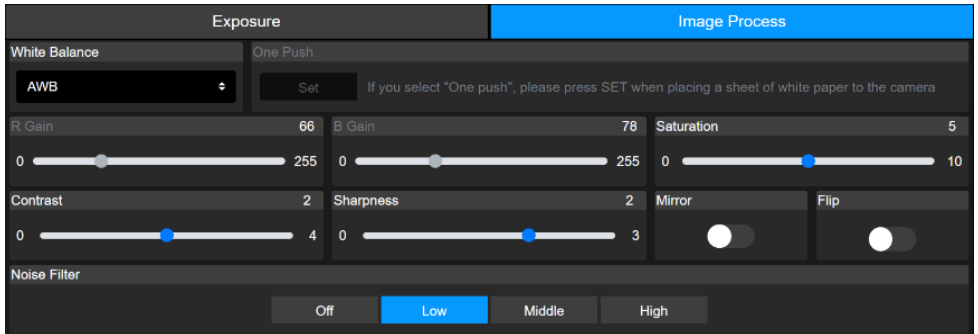

Item	Description
White Balance	<ul style="list-style-type: none"> Select Day in IR Cut Filter Mode, and then select a white balance mode. When Manual is selected, you can also adjust the R Gain and B Gain. When One Push is selected, place a piece of white paper in front of the camera lens and click Set to calibrate white balance.
Saturation	Adjust saturation, contrast and sharpness.
Contrast	
Sharpness	
Mirror	Select to horizontal or vertical flip camera view.
Flip	
Noise Filter	Select a noise filtering level.

Layout

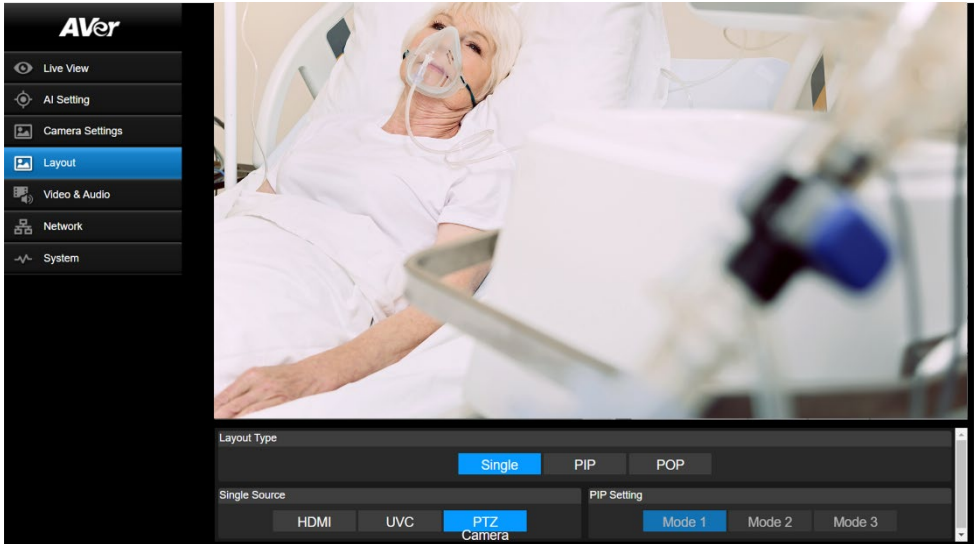

Item	Description
Layout Type	Select from Single , PIP (Picture-in-Picture), or POP (Picture-on-Picture) for multiple video sources display.
Single Source	Select a video input source from HDMI, UVC or the MD720UIS camera.
PIP Setting	When the system detects two video sources, you may switch the PIP layout.

Video & Audio

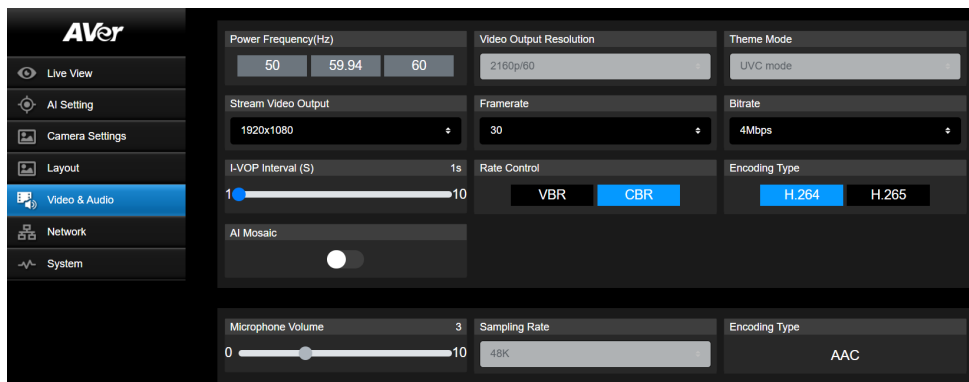

Video Setting

Item	Description
Power Frequency (Hz)	Select 50Hz , 59.94Hz or 60Hz based on your country or region.
Video Out Resolution	Select a video output. resolution RTSP: Max. 4K/30fps HDMI: Max. 4K 30Hz
Theme Mode	Select a video overlay to prioritize UVC or HDMI output.
Stream Video Output	Select a streaming output resolution for the live view.
Framerate	Select a framerate.
Bitrate	Select a bitrate.
I-VOP Interval (S)	<ul style="list-style-type: none"> Drag the slider to choose how often I-VOPs appear in a video stream. Shorter I-VOP intervals result in higher video quality but also larger file sizes.
Rate Control	Select VBR or CBR .
Encoding Type	Select H.264 or H.265 .
AI Mosaic	Turn on to pixelate the face or body on an RTSP stream for privacy.

Audio Setting

Item	Description
Microphone Volume	Drag the slider to adjust the microphone volume.
Sampling Rate	48K
Encoding Type	AAC

Network

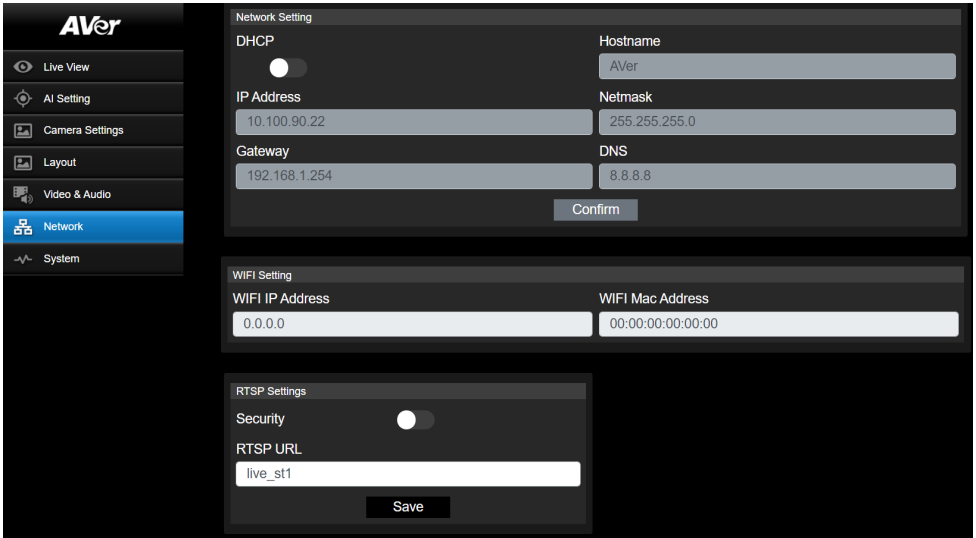

Item	Description
Network Setting	<p>The default network is DHCP. Click on the toggle to switch between DHCP and Static IP.</p> <ul style="list-style-type: none"> • DHCP: Turn on DHCP and click Confirm to save the setting. The camera will be assigned IP settings automatically. • Static IP: Turn off DHCP, enter IP Address, Netmask, Gateway and DNS, and click Confirm to save the settings.
WIFI Setting	<p>Display WIFI IP Address and Mac Address when connecting a WIFI dongle.</p>
RTMP Setting	<p>Stream live video to a video platform such as YouTube.</p> <ol style="list-style-type: none"> 1. Enter the Server URL and Stream Key of your video platform. Please refer to the instruction of your platform to obtain the server URL and stream key. 2. Click Start Stream to start streaming, Stop to stop streaming.
RTSP Settings	<p>Protect your video stream on media players such as VLC, PotPlayer and QuickTime by ensuring that only authorized users can access it.</p> <ul style="list-style-type: none"> • When Security is turned off: <ol style="list-style-type: none"> 1. Enter your camera's RTSP URL into the media player. 2. RTSP URL: rtsp://[camera IP address]/live_st1 Example: rtsp://192.168.1.100/live_st1 • When Security is turned on:

- | | |
|--|--|
| | <ol style="list-style-type: none">1. Enter your camera's RTSP URL and username/password into the media player.2. RTSP URL: rtsp://[username:password]@[camera IP address]/live_st1
Example: rtsp://1:1@192.168.1.100/live_st1
Username/password: camera's username/password (web interface login) |
|--|--|

System

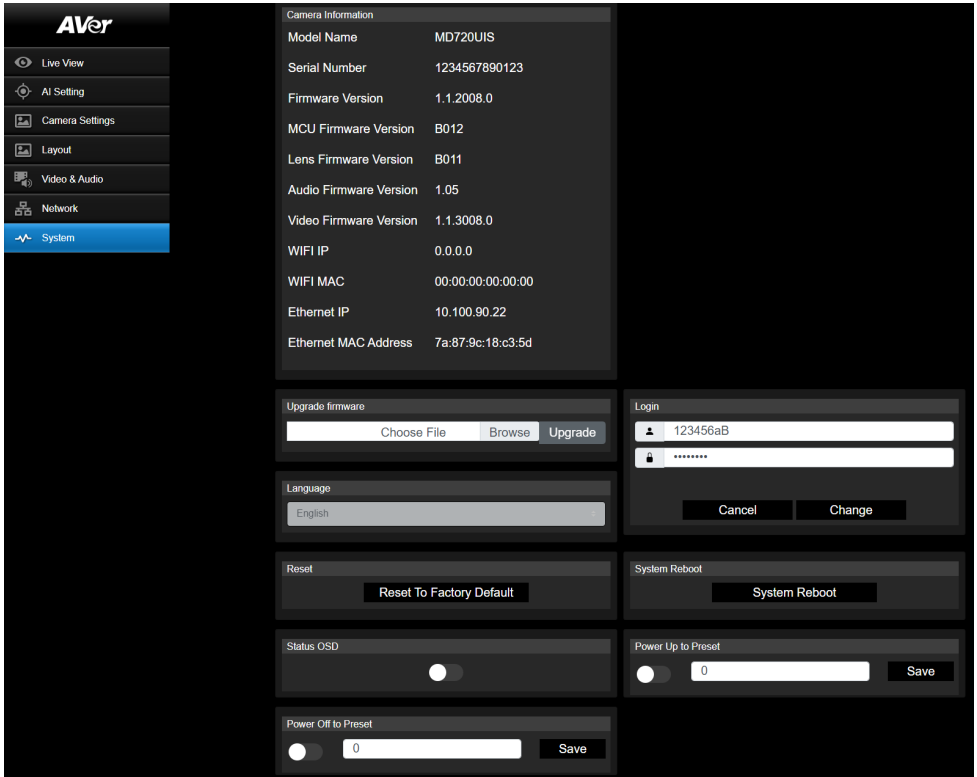

Item	Description
Camera Information	Display camera information.
Upgrade Firmware	<p>To upgrade the firmware:</p> <ol style="list-style-type: none"> 1. Download the latest firmware from the AVer Download Center (https://www.aver.com/download-center/). 2. On the Web interface, go to System > Upgrade firmware. 3. Click Browse to select the firmware. 4. Click Upgrade to start upgrading the firmware. 5. Refresh the browser after the upgrade process is complete. <p>[Note] Keep your camera connected to a power source during firmware upgrade. Network connection will be lost during the process and camera will reboot automatically after upgrading.</p>
Login	The default username/password is admin/admin . To change the username/password, enter the new username/password and click Change .

Language	Change the web interface language.
Reset	Reset the camera to factory default settings.
System Reboot	Restart your camera.
Status OSD	Enable to display preset status on the HDMI output during functions such as saving, loading and canceling presets.
Power Up to Preset	<p>Turn on to move the camera to the defined position after powering on.</p> <ul style="list-style-type: none"> • Click the toggle to turn on > enter a preset number > click Save. • Make sure the preset number has been defined before enabling this function.
Power Off to Preset	<p>Turn on to move the camera to the defined position before powering off.</p> <ul style="list-style-type: none"> • Click the toggle to turn on > enter a preset number > click Save. • Make sure the preset number has been defined before enabling this function.

Specifications

Operation System	
Operating System	Android™
Camera	
Image Sensor	1/2.8" CMOS
Effective Picture Elements	8 Megapixels
Output Resolutions	4K/30p, 1080p/60, 1080p/30, 1080p/25, 720p/60,
Minimum Illumination	0.5 lux (IRE50, F1.6, Max. AGC, 1/30)
S/N Ratio	≥ 50 dB
Gain	Auto, Manual
Shutter Speed	1/1 to 1/10,000 sec
Exposure Control	Auto, Manual, Priority AE (Shutter, IRIS), BLC, WDR
White Balance	Auto, Manual
Optical Zoom	20X
Viewing Angles	DFOV: 69.2° (Wide) to 4.1° (Tele) HFOV: 62.3° (Wide) to 3.6° (Tele) VFOV: 37.3° (Wide) to 2.1° (Tele)
Focal Length	f = 4.5 mm (Wide) to 90 mm (Tele)
Aperture (Iris)	F = 1.8 (Wide) to 4.7 (Tele)
Minimum Working Distance	0.1 m (Wide) , 1.2 m (Tele)
Pan / Tilt Angles	Pan: ±170°, Tilt: +90° / -90°
Pan / Tilt Speed (Manual)	Pan: 0.1° to 100° / sec, Tilt: 0.1° to 100° / sec
Preset Speed	Pan: 200° / sec, Tilt: 200° / sec
Preset Positions	256 (IP / USB)
Camera Control - Protocols	VISCA (IP), CGI (IP)
Image Processing	Mirror / Flip / Freeze / WDR / BLC
Power Frequencies	50 Hz, 60 Hz
AI Functions	
Modes	Face / Eyes Tracking, Fall / Bed Egress Detection
Privacy	
Protection Mode	Local Privacy Mode, Mosaic Function
General	
Power Requirement	AC100 – 240V to DC 12V/5A and above
Power Consumption	40W
PoE	PoE++ (IEEE 802.3bt)
Dimension (W x H x D)	273.57(W) x 233.4(H) x 169(D) mm

Net Weight	3kg
Application	Indoor
Privacy indicator light	Yes
Security	Kensington Slot
Remote Control	Infrared
Operating Conditions	Temperature : 0 °C to +40 °C Humidity : 20% to 80%
Storage Conditions	Temperature : -30 °C to +60 °C Humidity : 20% to 95%
Audio	
Embedded Speaker	Yes
Microphone	Yes, Microphone Array
AI Noise Reduction	Yes
Interface	
Video Outputs	HDMI, IP, USB-C (Rear)
Audio Outputs	HDMI, IP, USB-C, Line-out (Rear) *May vary depending on actual application scenarios
IP Streaming	
Resolution	4K 30fps
Network Video Compress Formats	H.264, H.265
Maximum Frame Rate	4K 30fps
Network Interface	10 / 100 / 1000 Base-T
Multi-Stream Capability	2 (RTSP / Web Page), 4K 30fps (max.)
Network Protocols	IPv4, TCP, UDP, ARP, ICMP, IGMP, HTTP, DHCP, RTP / RTCP, RTSP, VISCA over IP
USB	
Connector	USB 3.0
Video Format	MJPEG/YUY2
USB Video Class (UVC)	UVC 1.1
USB Audio Class (UAC)	UAC 1.0
Web UI	
Live Video Preview	Yes
Camera PTZ Control	Pan, Tilt, Zoom, Focus, Preset Control
Camera / Image	Exposure, White Balance, Image Process
Network Configuration	DHCP, IP Address, Gateway, Subnet Mask, DNS
Software Tools	
IP Search and Configuration Tool	Supports Windows® 7 or later

ViewCare	Supports Windows® 7 or later
PTZ Management	Supports Windows® 7 or later
PTZ Control Panel	Supports iOS & iPadOS® 11 or later
Warranty	
Camera	3 Years
Accessories	1 Year

Specifications are subject to change without prior notice.

Troubleshooting

How to open the on-screen display (OSD) menu?

1. Make sure the HDMI cable is connected to your camera and display.
2. On the remote control, press and hold **Menu**  for 3 seconds to open the OSD menu.
3. After opening the OSD menu, the LED indicator will appear solid purple.

Appendix

Voice Command List

To	Say
Activate voice control.	"Hi, AVer"
Switch image input source to HDMI.	"Watch TV" "Go to TV"
Go to home screen	"Go to home screen" "Go to homepage"
Enter Privacy Mode	"Go Privacy Mode" "Go to Privacy Mode" "Privacy Mode"
Back to Normal Mode	"Go Normal Mode" "Go to Normal Mode" "Normal Mode"
Return to camera home position	"Center the camera" "Center camera"
Calibrate the camera	"Calibrate the camera" "Calibrate camera"