

TabChargeCT

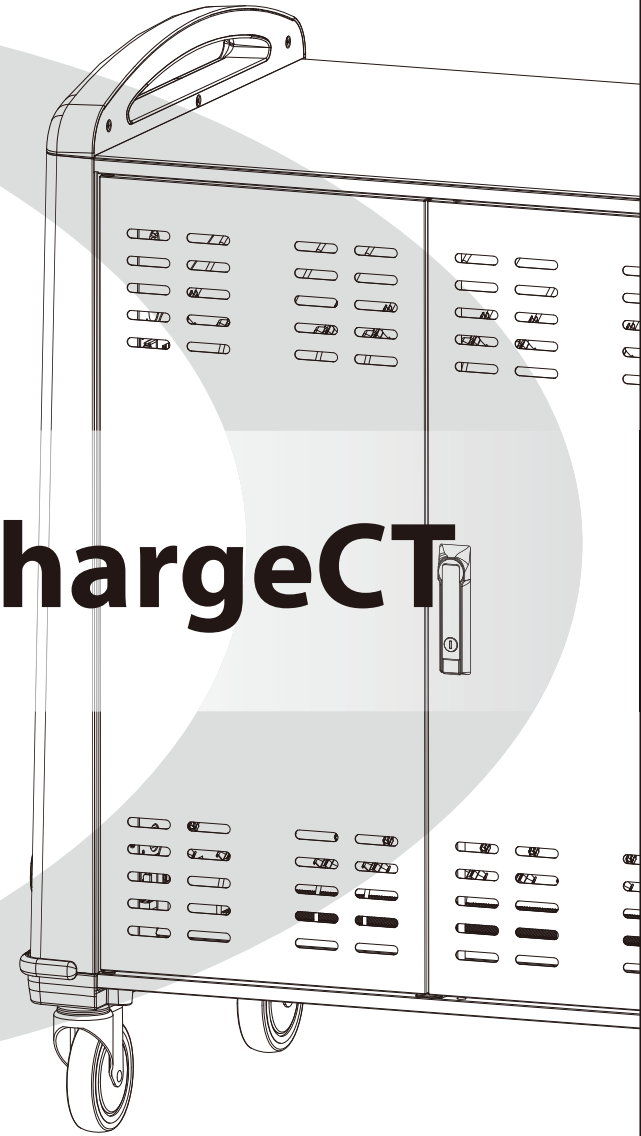

Aver[™]

www.averusa.com
www.aver.com.tw

UL[®] **US**
LISTED
I.T.E.
E341990

FC **CE**

Version:1.0

Feature

1. Charge up to 36 Chromebooks, Netbooks, Laptops and/or Tablets
2. Holds up to a 13" Chromebook, Netbook or Laptop with a maximum width of 47mm (1.85 inches) per slot
3. Custom adapter compartment for easy cable management
4. Pull-out shelves for easy access to devices
5. Highly robust 3-point steel locking mechanism for security
6. Smart timer for scheduling day/time/duration of charging
7. Smart power management prevents electrical circuit overload
8. Whole cart is UL/FCC/CE certified
9. 4 extra power outlets for external usage
10. 5" caster wheels with brake locks (2 rigid / 2 swiveling)

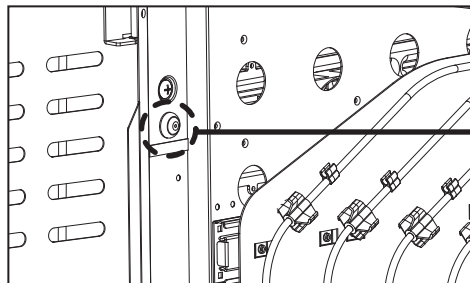

ON/OFF Switch

Charging the Chromebook / Tablet

To quickly start the charging function, please follow the steps below:

1. Connect main power chord of the cart to the wall outlet.
2. When the cart is powered on, the LED (see above picture) will turn a solid RED.
3. Press the LED button to start the charging function.
4. When it is charging, the RED LED flashes constantly. Press on it again to stop charging.
5. The default charging mechanism is set to cycle through each row of devices at a 15 minute interval. This will go on until each row is charged for a full 4 hour. In summary, it takes 12 hours to complete the default charging for all 3 rows.

Schedule charging

For schedule charging settings, please refer to OSD Timer instruction manual for details.

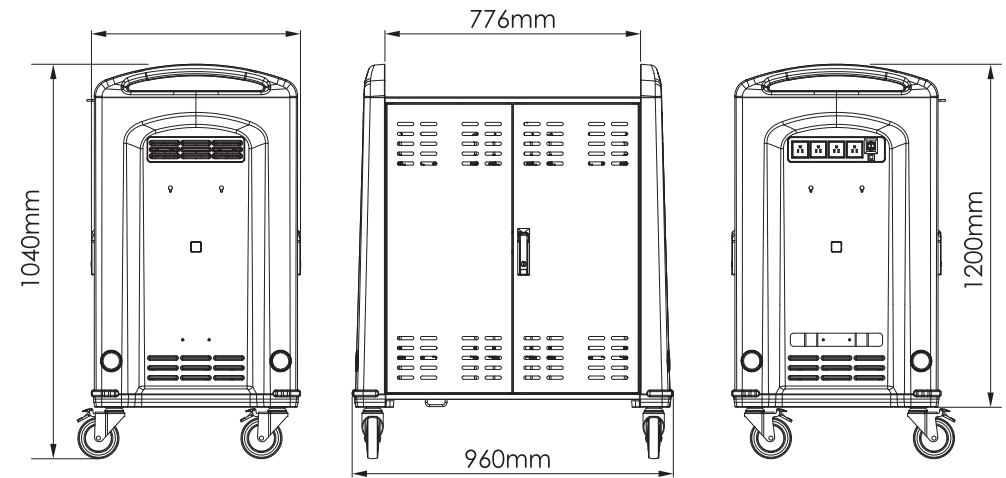

Rating Input	Output	4 Port outlet
AC 100-120V, 50/60Hz, 12A AC 220-240V, 50/60Hz, 10A	AC 100-120V, 50/60Hz, 11A AC 220-240V, 50/60Hz, 9A	Max. Current 8A

- Caution: 1. Adult operation and supervision is recommended at all times.
2. To reduce Risk of electric shock use only indoors.

Note: For warranty policy, please refer to the following: www.averusa.com for the Americas and www.aver.com for the rest of the world.

Accessory

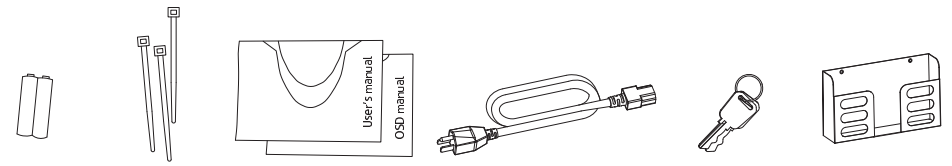

Battery Cable Ties (36pcs) Manual Power cord Key AP Holder

Instruction

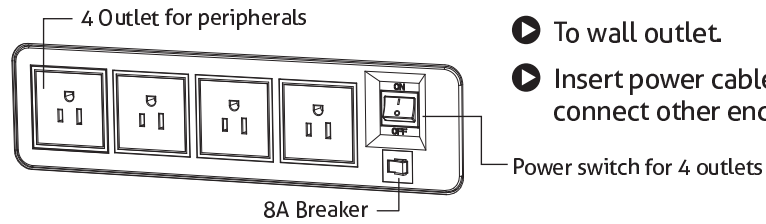
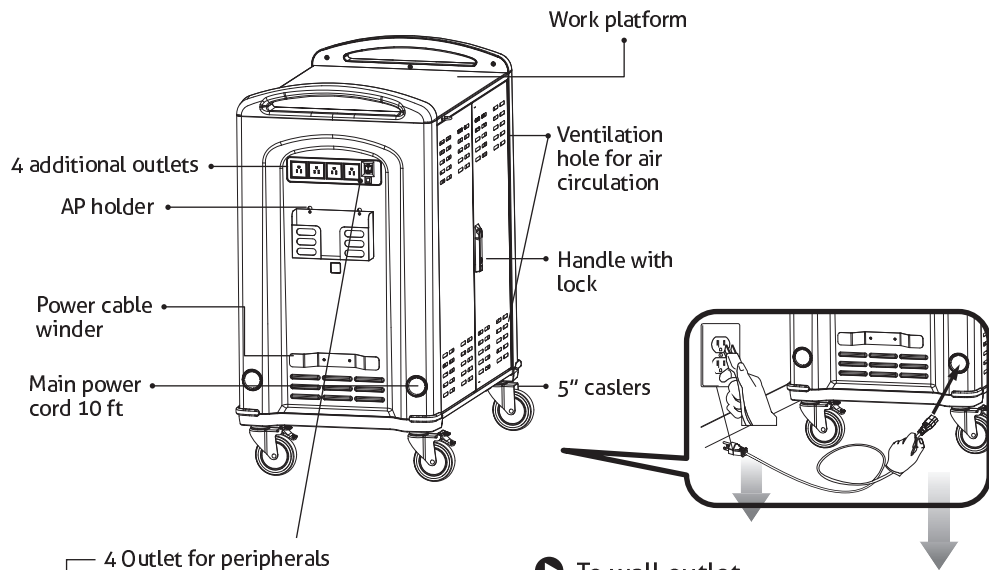

▶ Push back 8A breaker to resume.

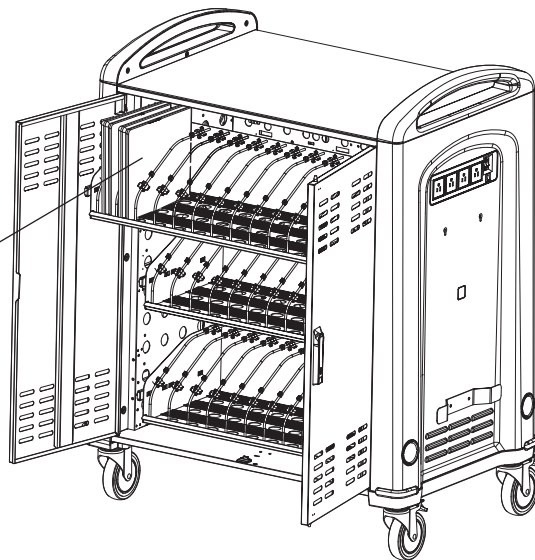

• Each tray holds up to a 13" chromebook, Netbook or Laptop with a maximum width of 47mm(1.85 inches) per slot.

Instruction

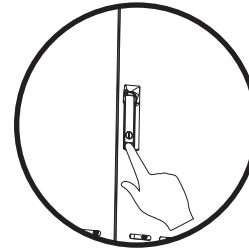

1 PUSH
"Push" and lift handle

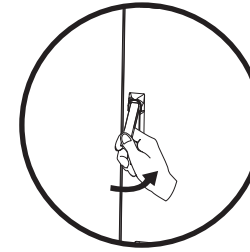

2 TURN
Lift up handle and turn towards right

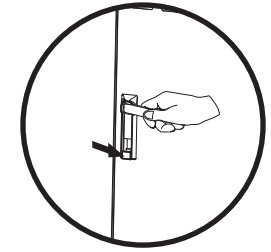

3 PULL
Pull out handle to open the door

▶ Security "U" chain for laptops, projectors or other devices can be secured on the work platform.

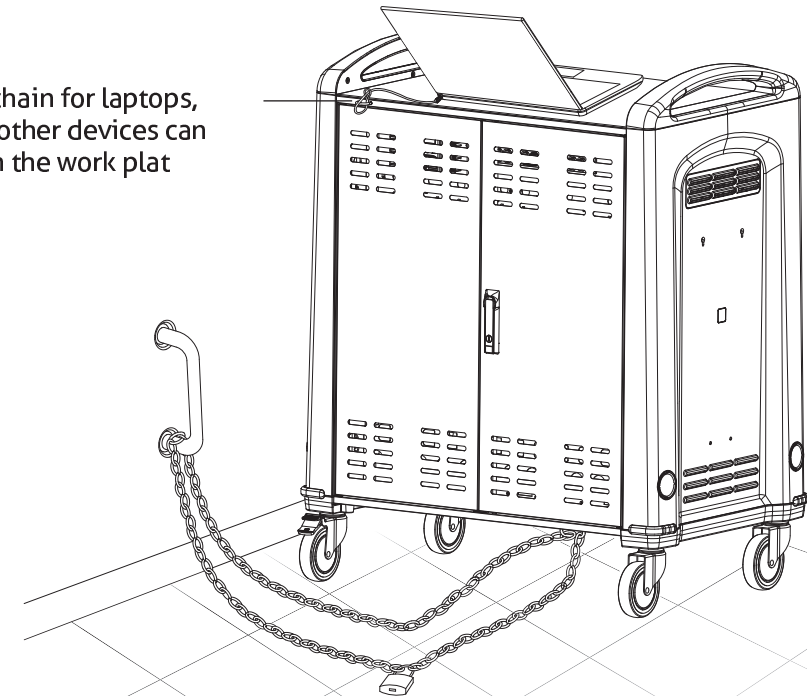

Instruction

▶ Cable clips for cable management

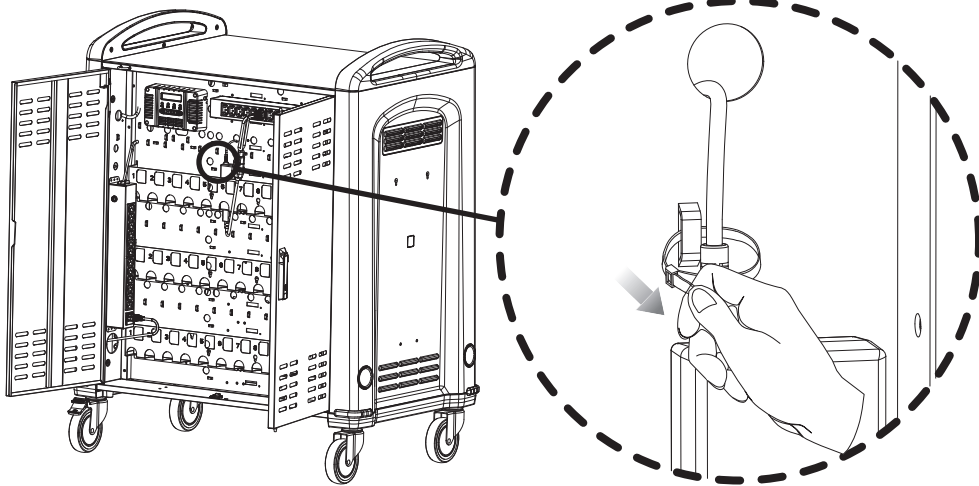
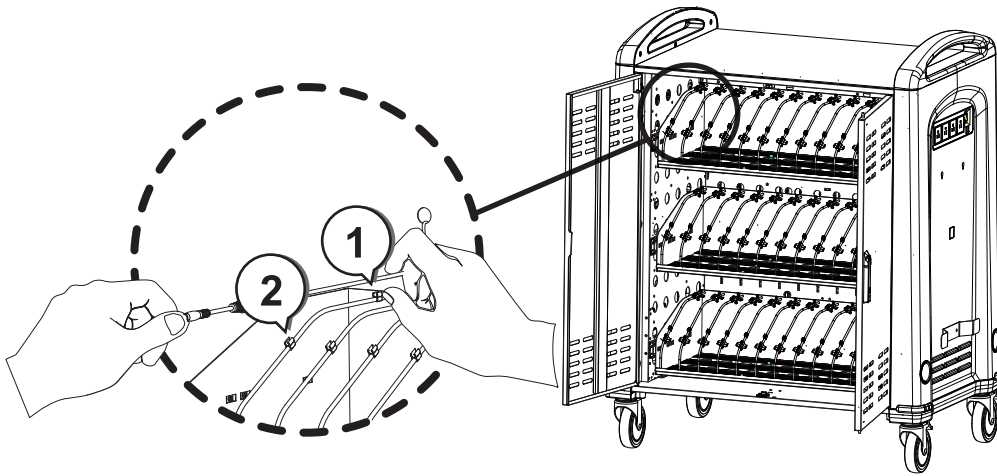

- ▶ Cable ties for securing and managing cables.
- ▶ Insert cable tie to the bracket. Use cable tie for cable management.

Instruction

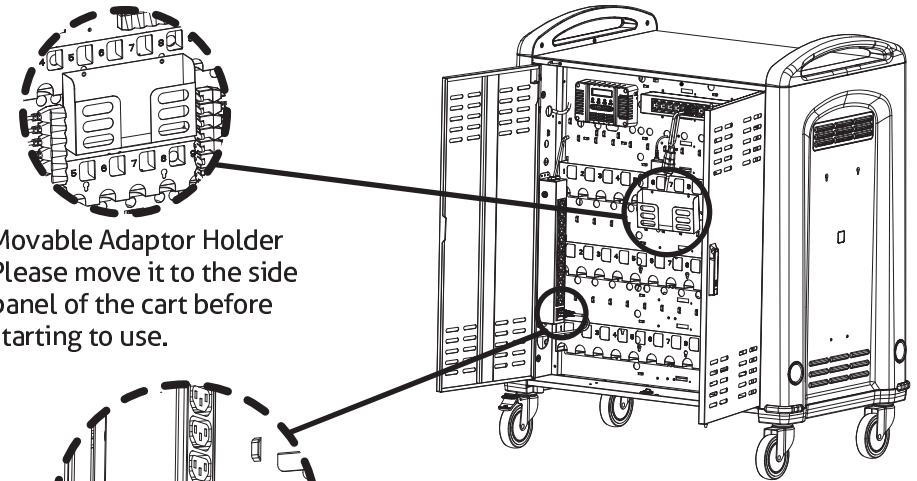
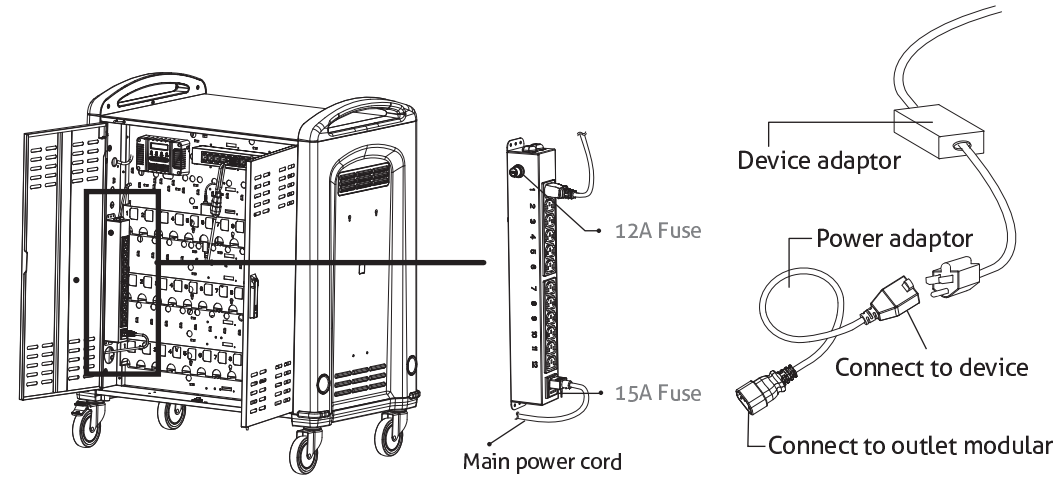

- ▶ Movable Adaptor Holder
Please move it to the side panel of the cart before starting to use.

Tips!

- ▶ Once plugged in to wall outlet then all four outlets will have power that can be regulated using the on/off button located next to the four outlets.
- ▶ When notebook is charging, the four extra outlet will have no power.