

# AVerVision M70

## User Manual



## Federal Communications Commission Statement (Class A)



NOTE- This equipment has been tested and found to comply with the limits for a Class A digital device, pursuant to Part 15 of the FCC Rules. These limits are designed to provide reasonable protection against harmful interference in a residential installation. This equipment generates uses and can radiate radio frequency energy and, if not installed and used in accordance with the instructions, may cause harmful interference to radio communications. However, there is no guarantee that interference will not occur in a particular installation. If this equipment does cause harmful interference to radio or television reception, which can be determined by tuning the equipment off and on, the user is encouraged to try to correct the interference by one or more of the following measures:

- Reorient or relocate the receiving antenna.
- Increase the separation between the equipment and receiver.
- Connect the equipment into an outlet on a circuit different from that to which the receiver is connected.
- Consult the dealer or an experienced radio/television technician for help.

### Class A ITE:

Class A ITE is a category of all other ITE which satisfies the class A ITE limits but not the class B ITE limits. Such equipment should not be restricted in its sale but the following warning shall be included in the instructions for use:

**Warning** - This is a class A product. In a domestic environment this product may cause radio interference in which case the user may be required to take adequate measures.

### COPYRIGHT

©2015 AVer Information Inc. All rights reserved.

All rights of this object belong to AVer Information Inc. Reproduced or transmitted in any form or by any means without the prior written permission of AVer Information Inc. is prohibited. All information or specifications are subject to change without prior notice.

### TRADEMARKS

“AVer” is a trademark owned by AVer Information Inc. Other trademarks used herein for description purpose only belong to each of their companies.

### NOTICE

SPECIFICATIONS ARE SUBJECT TO CHANGE WITHOUT PRIOR NOTICE. THE INFORMATION CONTAINED HEREIN IS TO BE CONSIDERED FOR REFERENCE ONLY.

### WARNING

TO REDUCE RISK OF FIRE OR ELECTRIC SHOCK, DO NOT EXPOSE THIS APPLIANCE TO RAIN OR MOISTURE. WARRANTY VOID FOR ANY UNAUTHORIZED PRODUCT MODIFICATION.



THE MARK OF CROSSED-OUT WHEELED BIN INDICATES THAT THIS PRODUCT MUST NOT BE DISPOSED OF WITH YOUR OTHER HOUSEHOLD WASTE. INSTEAD, YOU NEED TO DISPOSE OF THE WASTE EQUIPMENT BY HANDING IT OVER TO A DESIGNATED COLLECTION POINT FOR THE RECYCLING OF WASTE ELECTRICAL AND ELECTRONIC EQUIPMENT. FOR MORE INFORMATION ABOUT WHERE TO DROP OFF YOUR WASTE EQUIPMENT FOR RECYCLING, PLEASE CONTACT YOUR HOUSEHOLD WASTE DISPOSAL SERVICE OR THE SHOP WHERE YOU PURCHASED THE PRODUCT.

## **Remote Control Battery Safety Information**

- Store batteries in any cool & dry place.
- Do not dispose used batteries in domestic waste. Dispose batteries at special collection points or return to stores if applies.
- Remove the batteries if they are not in use for long period of time. Battery leakage and corrosion can damage the remote control, dispose batteries safely.
- Do not mix and use old and new batteries.
- Do not mix and use different types of batteries: alkaline, standard (carbon-zinc) or rechargeable (nickel-cadmium).
- Do not dispose batteries in a fire.
- Do not attempt to short circuit the battery terminals.

# Table of Contents

<b>Package Contents</b> .....	<b>1</b>
<b>Optional Accessories</b> .....	<b>1</b>
<b>Get Familiar with the AVerVision M70</b> .....	<b>2</b>
Right Panel .....	2
Rear Panel .....	3
Left Panel .....	3
Control Panel .....	4
Remote Control .....	5
<b>Making the Connections</b> .....	<b>8</b>
Set the TV-RGB Switch Setting .....	8
Connect to a Monitor or LCD/DLP Projector .....	8
Connect to a Monitor or LCD/DLP Projector with HDMI interface .....	9
Connect to a TV .....	9
Connecting the Power .....	10
Connect to a Computer .....	10
Connect to a Computer via USB .....	11
Connect an External Microphone .....	11
Connect an Amplified Speaker .....	12
Connect to a Microscope .....	12
<b>Setting Up AVerVision M70</b> .....	<b>13</b>
Camera Head .....	13
Mechanical Arm .....	14
Infrared Sensor .....	14
Mounting the M70 on a Flat Surface .....	15
Anti-glare Sheet .....	15
External Memory Storage .....	16
Insert an SD Card .....	16
Insert a USB Flash Drive .....	16
<b>OSD MENU</b> .....	<b>17</b>
Navigate the Menu and Submenu .....	18
Image .....	18
Brightness .....	18
Contrast .....	18
Mode .....	19
Effect .....	19
Mirror .....	19
Advanced .....	19
Auto Image .....	20

Exposure .....	20
White Balance .....	20
Focus .....	20
Presentation.....	21
Spotlight .....	21
Visor .....	21
PIP .....	22
Split Screen .....	22
Timer .....	23
Setting .....	23
Capture .....	23
Resolution .....	23
Quality .....	23
Type .....	24
Interval .....	24
Recording.....	24
Storage.....	24
Format.....	24
USB to PC.....	25
Flicker.....	25
System.....	25
Language .....	25
Output Display.....	25
Backup .....	26
Save Setting.....	26
Recall Setting .....	26
Information .....	26
Default.....	26
Playback.....	27
Slide Show .....	27
Interval .....	27
Slide Show Effect .....	27
Current Storage.....	27
Delete All .....	27
Annotation.....	28
Connecting a USB mouse .....	28
Using the Annotation Control Panel.....	29
<b>Transfer Captured Images/Videos to a computer.....</b>	<b>30</b>
<b>Technical Specifications.....</b>	<b>31</b>
Image .....	31

Optics .....	31
Power .....	31
Lighting.....	31
Input/Output.....	31
Dimension .....	31
External Storage.....	32
<b>RS-232 Diagram Connection .....</b>	<b>32</b>
<b>RS-232 Cable Specifications .....</b>	<b>32</b>
<b>RS-232 Transmission Specifications .....</b>	<b>33</b>
RS-232 Communication Format .....	33
RS-232 Send Command Table .....	33
RS-232 Get Command Table.....	36
<b>Troubleshooting .....</b>	<b>39</b>
<b>Limited Warranty .....</b>	<b>41</b>

# Package Contents

Make sure the following items are included in the package.

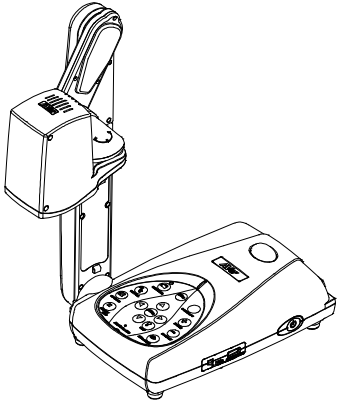

AVerVision M70

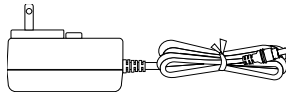

Power Adapter (12V, 2A)

\* The power adapter will vary depending on the standard power outlet of the country where it is sold.

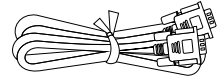

RGB Cable

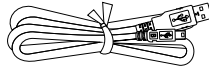

USB Cable

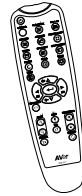

Remote Control  
(batteries included)

# Optional Accessories

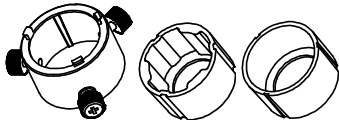

Microscope Adapter  
(28mm & 34mm Rubber Coupler are included)

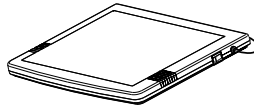

Light Box

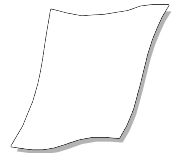

Anti-glare Sheet



RS-232/CVBS Cable

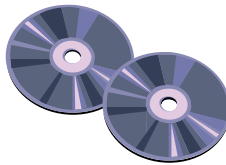

Software & Manual CD\*



Carrying Bag

\*For User Manual and Software, please visit the link below <http://averusa.com/classroom-technology/support/>.

# Get Familiar with the AVerVision M70

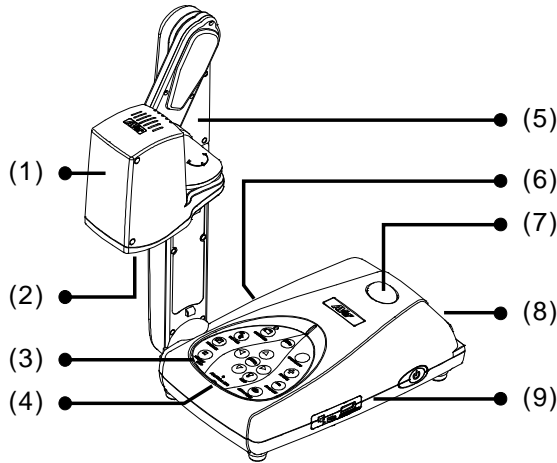

(fig. 1.1)

Name	Function
(1) Camera head	Contain the camera sensor.
(2) Camera lens	Focus the image in the camera.
(3) Control panel	Easy access to various functions.
(4) Built-in MIC	Record audio when recording video clip. The recorded sound will be in monophonic.
(5) Arm	Extendable for viewing coverage.
(6) Left panel	Connections for LCD monitor using HDMI cable, microphone, speaker, computer, SD card, and TV-RGB display output switch.
(7) IR sensor	Receive remote control commands.
(8) Rear panel	Connections for power, computer for RGB input display and LCD monitor using RGB cable.
(9) Right panel	On/off switch for USB flash drive port and power button.

## Right Panel

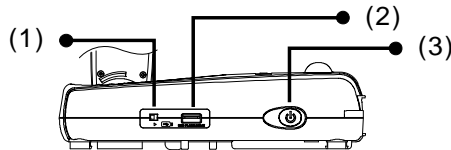

(fig. 1.2)

Name	Function
(1) USB PC - USB Flash Drive switch	Switch to right (▶) for audio video recording directly to a USB flash drive and left (◀) when connecting AVerVision M70 to a computer using a USB cable.
(2) USB Thumb Drive port	Insert a USB flash drive for audio video recording storage.
(3) Power button	Turn the unit on/standby mode.



## Rear Panel

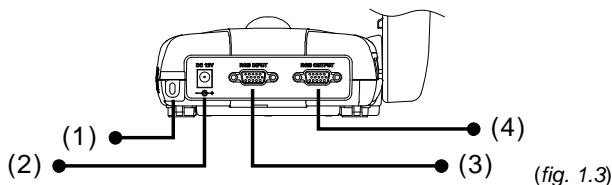

Name	Function
(1) Antitheft Slot	Attach a Kensington compatible security lock or antitheft device.
(2) DC12V port	Connect the power adapter into this port.
(3) RGB INPUT port	Input the signal from a computer or other sources and pass it through to the RGB OUT port only. Connect this port to the RGB/VGA output port of a computer.
(4) RGB OUTPUT port	Connect the AVerVision M70 to any display device with RGB cable

## Left Panel

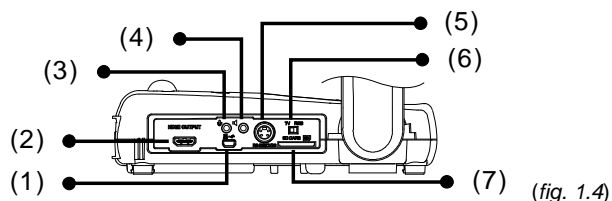

Name	Function
(1) Mini USB port	Connect to a USB port of a computer with a USB cable and use AVerVision M70 as a USB Camera or transfer the captured images/videos either from the memory source to computer.
(2) HDMI OUTPUT	Output the video signal from the main system on an LCD monitor with HDMI interface using HDMI cable.
(3) MIC port	Connect a 3.5mm plug microphone. The built-in mic will be disabled when an external MIC is connected to this port.
(4) Speaker port	Connect to an amplified speaker.
(5) RS-232/CVBS port	Connect the RS-232/CVBS cable (optional) into this port. The RCA jack outputs the video signal from the camera to a TV or video equipment. The RS-232 jack is used to connect to computer serial port or to any control panel or for centralized control if desire.
(6) TV-RGB switch	TV switch to output display video from RS232/CVBS (via RCA connection), and RGB to RGB and HDMI OUTPUT ports.
(7) SD card slot	Insert the SD card with the label facing up.

## Control Panel

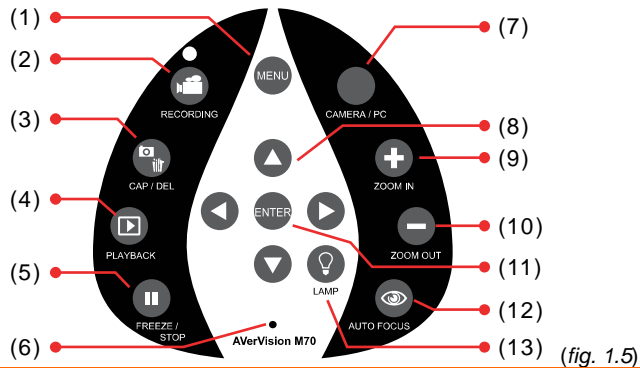

Name	Function
(1) MENU	Open and exit the OSD menu.
(2) RECORDING	Start/Stop audio & video recording. Audio and video recording can be saved on a SD card or an USB Flash drive only. See <a href="#">External Memory Storage</a> .
(3) CAP/DEL	<ul style="list-style-type: none"> <li>- Capture picture in Camera mode. In continuous capture mode, press this button again to stop.</li> <li>- Delete the selected picture/video in Playback mode.</li> </ul>
(4) PLAYBACK	View & playback captured still images and audio video files.
(5) FREEZE / STOP	<ul style="list-style-type: none"> <li>- Pause or resume image display in Camera mode.</li> <li>- Stop audio &amp; video playback in Playback mode.</li> </ul>
(6) Built-in MIC	Record audio automatically when recording video clip.
(7) CAMERA / PC	Switch between Camera and Computer.
(8) ▲, ▼, ◀, & ▶	<ul style="list-style-type: none"> <li>- Pan and zoom-in image (above digital zoom level) in both live and playback mode.</li> <li>- Select options in OSD menu.</li> <li>- Use ▲ &amp; ▼ to increase and decrease the video playback volume.</li> <li>- Use ◀ &amp; ▶ to play the video backward and forward.</li> <li>- Move the Spotlight frame and Visor screen cover.</li> </ul>
(9) ZOOM IN	Increase the image magnification in camera and picture playback mode.
(10) ZOOM OUT	Decrease the image magnification in camera and picture playback mode.
(11) ENTER	<ul style="list-style-type: none"> <li>- Make a selection in Playback mode and OSD menu.</li> <li>- Start/Pause video playback.</li> </ul>
(12) AUTO FOCUS	Adjust the focus automatically.
(13) LAMP	Turn the overhead light on/off.

## Remote Control

The remote control requires two (2) “AAA” size batteries (supplied), make sure batteries are installed properly before use. You can access all the features of AVerVision M70 with the remote.

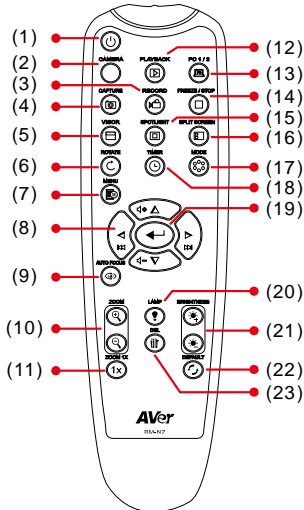

(fig. 1.6)

Name	Function
(1) POWER	Turn the unit on/standby.
(2) CAMERA	Camera mode displays the video signal from the built-in camera.
(3) RECORD	Start/Stop audio & video recording. Video recording can only be saved either in a SD memory card or a USB flash drive.
(4) CAPTURE	Capture still image in Camera mode. In continuous capture mode, press this button again to stop.
(5) VISOR	Call the Visor submenu. Visor covers part of the presentation screen and allow presenter to reveal the material as desire. In the Visor submenu, the following options are available. <div data-bbox="674 678 909 853" data-label="Image"> </div> <p><b>ON/OFF</b> – select to run/cancel the Visor.</p> <p>Press  to move to the next selection.</p> <p><b>Shade</b> – set the opacity level of the covered area. The shaded area will completely turns black when it is set to level 100. Press  to move to the next selection.</p> <p><b>OK</b> – press  for the setting to take effect. If you select ON, upper part of the presentation screen is slightly exposed. Use the , , , &amp;  buttons to reveal more of the covered area; and OFF will close the submenu.</p> <p>To turn off Visor, press  again.</p>
(6) ROTATE	Rotate the image by 90° in Camera mode and Playback mode.
(7) MENU	Open and exit the OSD menu.

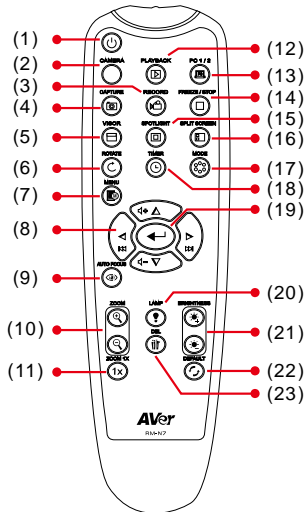

(fig. 1.6)

Name	Function
------	----------

(8) ▲, ▼, ◀, & ▶	<ul style="list-style-type: none"> <li>- Pan and zoom-in image (above digital zoom level) in both live and playback mode.</li> <li>- Select options in OSD menu.</li> <li>- Use ▲ &amp; ▼ to increase and decrease the video playback volume.</li> <li>- Use ◀ &amp; ▶ to play the video backward and forward.</li> </ul> <p>Move the Spotlight frame and Visor screen cover.</p>
(9) AUTO FOCUS	Adjust the focus automatically.
(10) ZOOM +/-	<ul style="list-style-type: none"> <li>- Increase/decrease the image magnification in camera and picture playback mode.</li> <li>- Use to easily page up and page down 16-thumbnail picture preview.</li> </ul>
(11) ZOOM RESET	Reset zoom level to 100%.
(12) PLAYBACK	View the captured picture/video from the memory in 16-thumbnail images.
(13) PC 1/2	PC mode displays the video signal from the RGB INPUT port of M70.
(14) FREEZE / STOP	<ul style="list-style-type: none"> <li>- Freeze live images.</li> <li>- Stop video playback.</li> </ul>
(15) SPOTLIGHT	<p>Call the Spotlight submenu. Spotlight overlays a box frame on the presentation screen. You can adjust the box size and move it around.</p> <p>In the Spotlight submenu, the following options are available.</p>





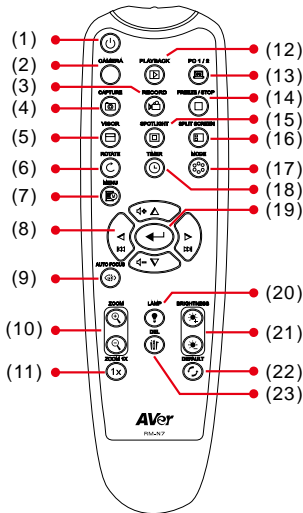

**ON/OFF** – select to run/cancel the Spotlight. Press ◀ to move to the next selection.

**Shade** – set the opacity level of the area outside the box. The shaded area will completely turns black when it is set to level 100. Press ◀ to move to the next selection.



(fig. 1.6)





Name	Function
(15) SPOTLIGHT	<p><b>Color</b> – select the Spotlight frame color.</p> <p>Press  to move to the next selection.</p> <p><b>OK</b> – press  for the setting to take effect. If you select ON, the frame will appear and blink, use the ▲, ▼, ◀, &amp; ▶ buttons to adjust the frame size and press  to set the desired size; and OFF will close the submenu.</p> <p>To turn off Spotlight, press  again.</p>
(16) SPLIT SCREEN	<p>Divide the screen into two. One side displays the live image from the built-in camera and the other side displays 8-thumbnail size picture/video from the memory.</p>
(17) MODE	<p>Select from 6 type of modes:</p> <p><b>Sharp</b> - adjust the contrast along the edges making text appear more visible.</p> <p><b>Graphics</b> - adjust the gradient of image.</p> <p><b>Motion</b> - increase frame rate. Sufficient lighting is required when using this mode.</p> <p><b>Microscope</b> - automatically adjust optical zoom for microscopic viewing.</p> <p><b>Macro</b> - set to view when object is only 5 –10cm away from the camera.</p> <p><b>Infinite</b> - set to view when subject is at least 80cm away from the camera.</p>
(18) TIMER	<p>Call the Timer submenu. Select to Start/Pause/Stop the timer countdown and set the timer duration.</p>
(19) 	<ul style="list-style-type: none"> <li>- Make a selection in Playback mode and OSD menu.</li> <li>- Play/Pause video playback.</li> </ul>
(20) LAMP	<p>Turn the overhead light on/off.</p>
(21) BRIGHTNES S +/-	<p>Adjust the brightness.</p>
(22) DEFAULT	<p>Reset to factory default setting.</p>
(23) DEL	<p>Delete the selected picture/video in Playback mode.</p>

## Making the Connections

Before making the connection, make sure the power of all devices are turned off. If you are not sure on where to connect, simply follow the illustrated connections below and also refer to the user manual of the device you are connecting the AVerVision M70 with.

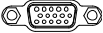
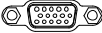
### Set the TV-RGB Switch Setting

The TV-RGB switch determines the display output selection. Switch it to RGB (right) to output signal using RGB/HDMI connection and TV (left) to output signal using RCA connection. (see fig. 1.4 # 6)

Switch	AVerVision Port		Display Device Port
RGB	 RGB OUTPUT	To	 RGB INPUT
	 HDMI OUTPUT		 HDMI INPUT
TV	 RS232/CVBS (use RS-232/CVBS cable) (optional)		 VIDEO IN

### Connect to a Monitor or LCD/DLP Projector

Locate the RGB (VGA) input port of the graphics display device and connect it to RGB OUTPUT port of AVerVision M70.



Make sure the TV/RGB switch is set to RGB.

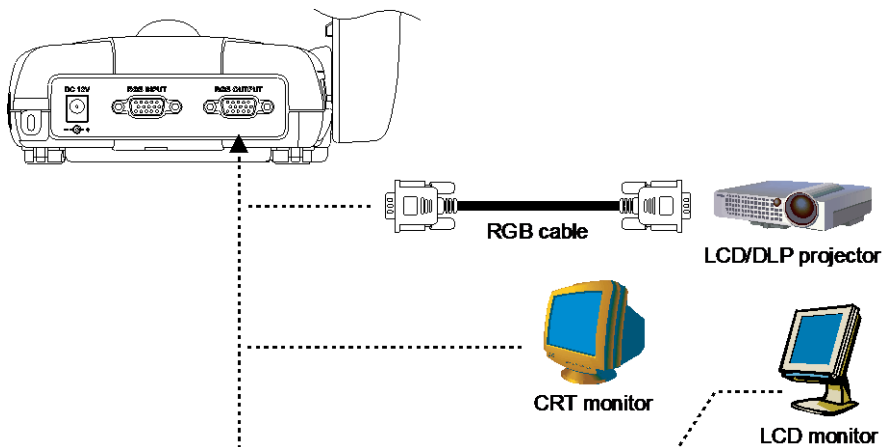

# Connect to a Monitor or LCD/DLP Projector with HDMI interface

Locate the HDMI input port of the display device and connect it to HDMI OUTPUT port of AVerVision M70.



Make sure the TV/RGB switch is set to RGB.

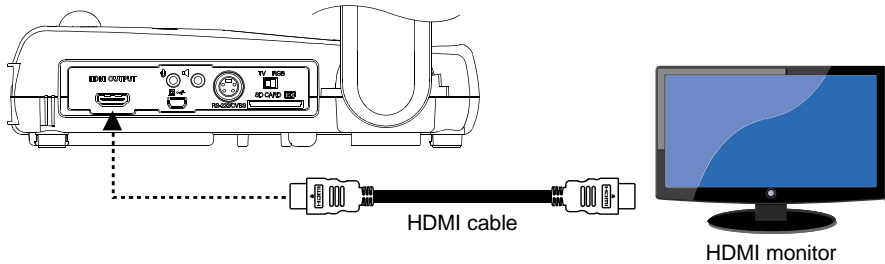

# Connect to a TV

Locate the VIDEO or SCART RGB (if applicable) input port of the TV or Video equipment (i.e., VCR) to record your presentation and connect it to RCA jack of RS-232/CVBS cable (optional).

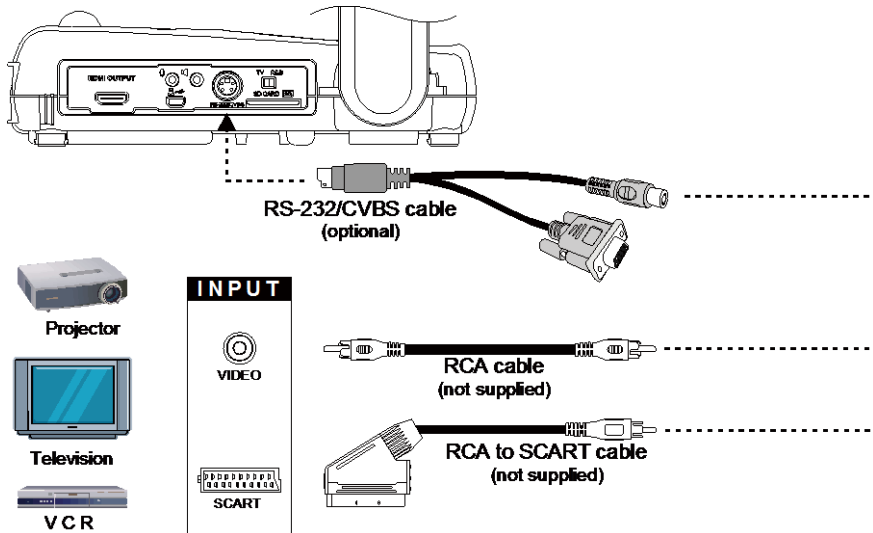

## Connecting the Power

Connect the power adapter to a standard 100V~240V AC power outlet. The unit automatically in standby mode once the power is connected. Press  to turn on.

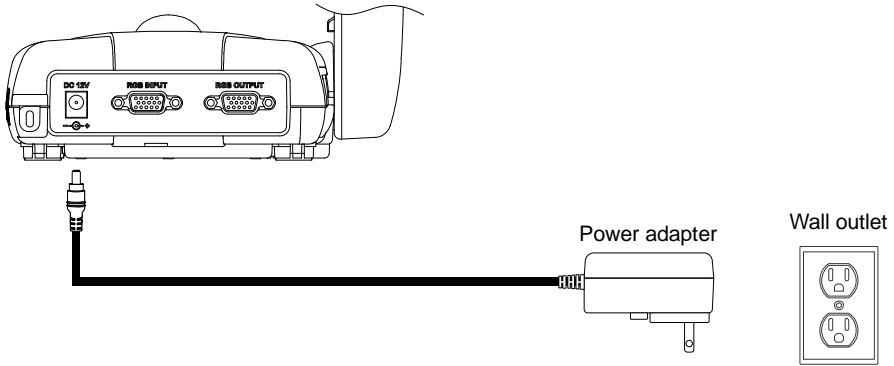

## Connect to a Computer

Locate the RGB (VGA) output port of the computer or laptop and connect it to RGB INPUT port of AVerVision M70. The video signal from the RGB INPUT port is streamed to RGB OUTPUT port.



- To display computer image, press Camera/PC button on the control panel or remote control to switch AVerVision M70 to computer mode.
- For laptop to output display image, use the keyboard command (FN+F5) to switch between the display modes. For different command, please refer to your laptop manual.

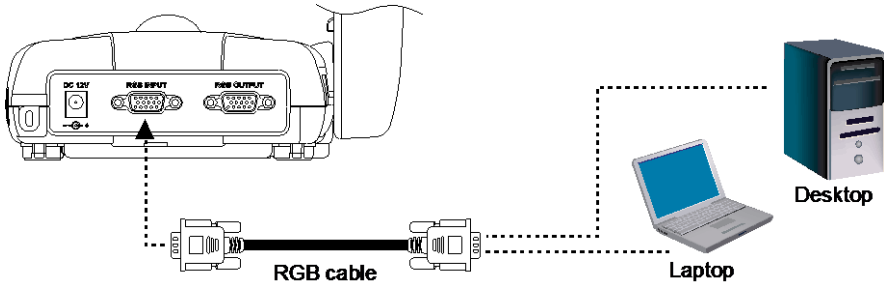



## Connect to a Computer via USB

Locate the USB port of the computer or laptop and connect it to USB port of AVerVision M70. This enables you to use AVerVision M70 as a USB Camera or to transfer the captured pictures/videos from the memory and to computer. Also see “Transfer File from AVerVision M70 to PC”.



Make sure the USB Flash Drive switch (see fig. 1.2 #1) is set to the left.

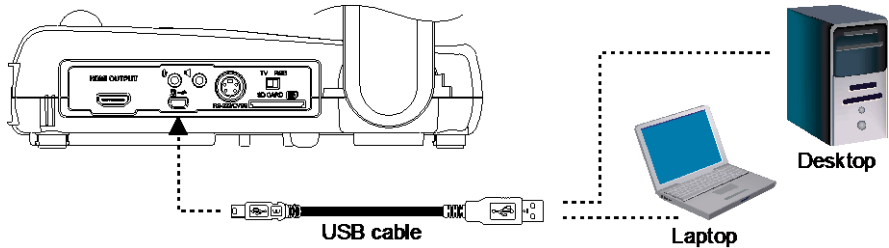

## Connect an External Microphone

Plug a 3.5mm mono microphone to  port. The built-in microphone on the control panel will be disabled when an external microphone is connected. The recorded audio will be in monophonic sound.

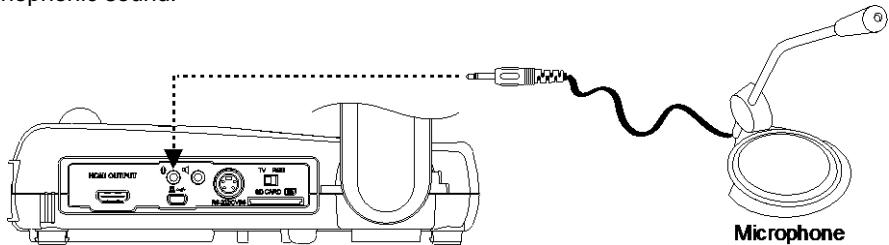

## Connect an Amplified Speaker

Plug a 3.5mm plug amplified speaker to  port. Only the audio from the video playback is supported.



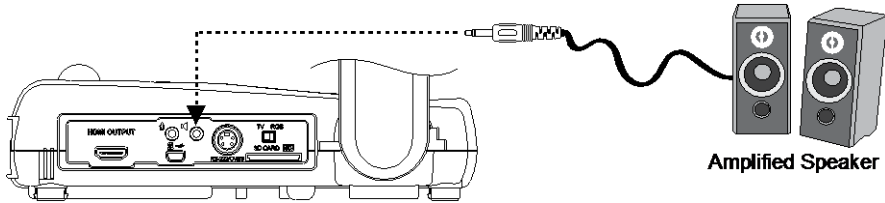

We recommend connecting an amplified speaker to the Audio output port. Take caution when using earphones. Adjust the volume down on the remote to prevent hearing damage due to loudness.



## Connect to a Microscope

Connect the AVerVision M70 to a microscope enables you to examine microscopic objects on a big screen.

1. Change the image display mode to Microscope. Press **MENU** > select **IMAGE** tab > select **MODE** > select  (**microscope**) and press .

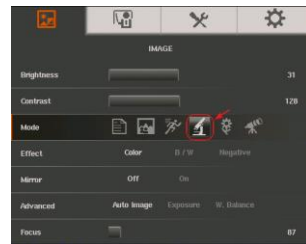

2. Aim the camera head at the farthest point and press **AUTO FOCUS**.
3. Adjust the focus of the microscope.

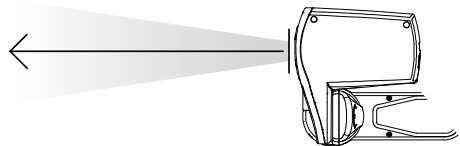

4. Select the appropriate rubber coupler size for the microscope eyepiece and insert it in the microscope adapter.

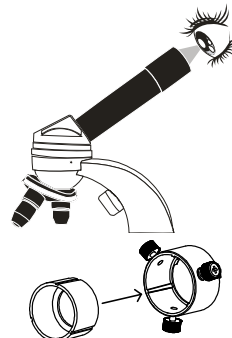

5. Remove the microscope eyepiece from the microscope and connect it to the microscope adapter with the rubber coupler inserted. Fasten the 3 bolts until the adapter secures the eyepiece.



For the eyepiece, we suggest using 15.5mm eye relief or higher.

6. Attach the microscope adapter to the AVerVision camera head. Then connect it to the AVerVision and microscope.

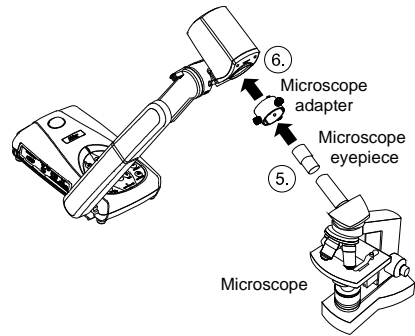

## Setting Up AVerVision M70

This section provides useful tips on how to adjust the AVerVision M70 to meet your needs.

### Camera Head

The camera head can turn freely at 90° to the left and right and up and down.

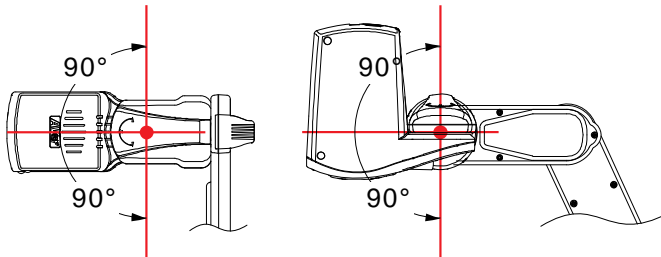

If the camera head is in upright position, you can also press ROTATE on the remote control twice to rotate the image in 180°.

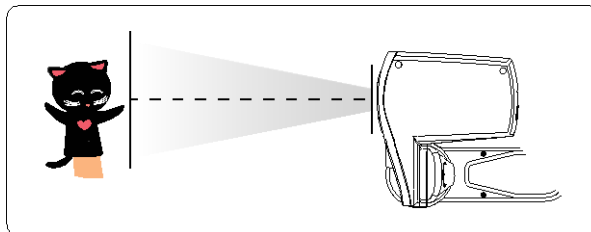

## Mechanical Arm

The mechanical arm design can extend for a full A4 paper viewing.

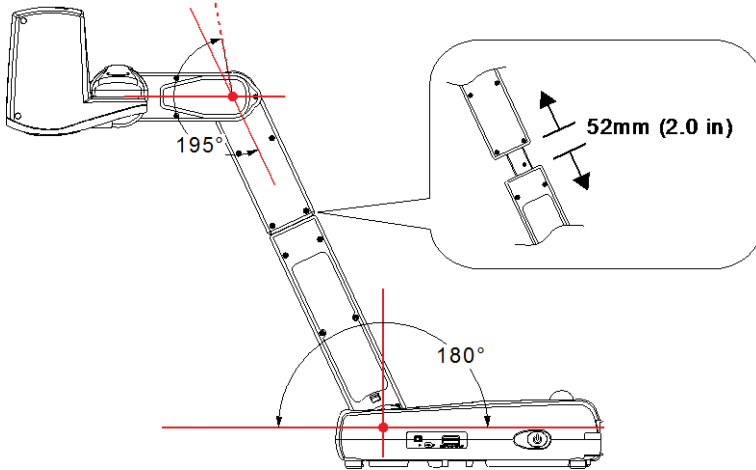

## Infrared Sensor

Aim the remote control at the infrared sensor to operate the unit.

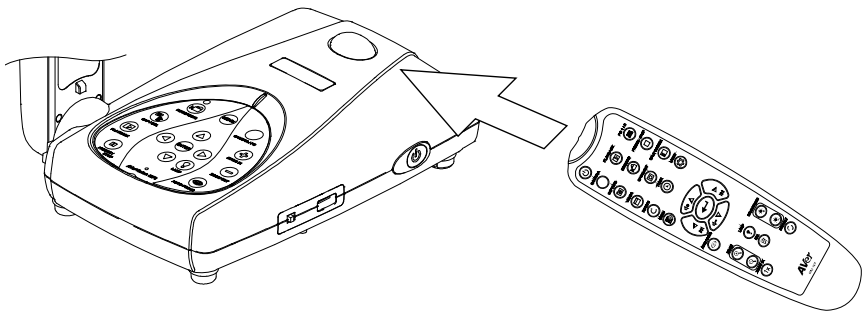

## Mounting the M70 on a Flat Surface

Measure and mark the horizontal of 75 mm and vertical of 70 mm from the center line distance between the holes on the flat surface as describe in the illustration below. Use 4 pieces of M4.0 screws for 6 mm holes and secure the M70 on the flat surface.

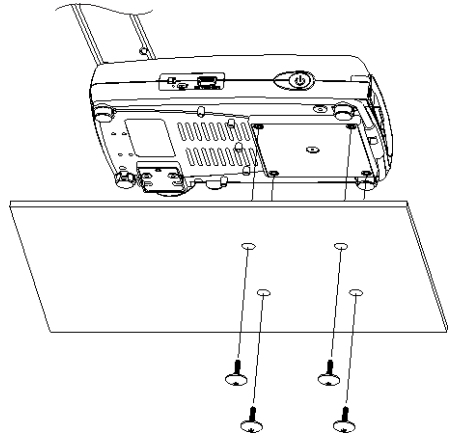
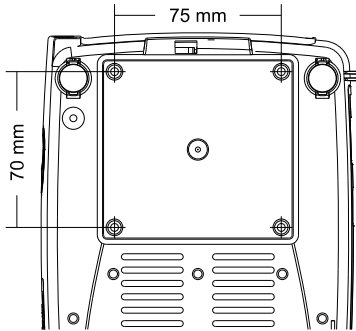

## Anti-glare Sheet

The anti-glare sheet is a special coated film that helps eliminate any glare that maybe encountered while displaying very shiny objects or glossy surfaces such as magazines and pictures. To use, simply place the anti-glare sheet on top of the shiny document to reduce reflected light.

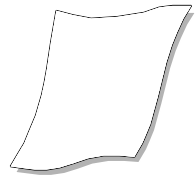

## External Memory Storage

AVerVision M70 supports both SD memory card and USB flash drive for more image capture and audio & video recordings. AVerVision M70 can detect when there is an external storage media and automatically switch to the last detected storage. If no external storage is connected, all captured still images will be saved in the built-in memory.

### Insert an SD Card

Insert the card with the contact facing down until it reaches the end. To remove the card, push to eject and pull the card out. The supported SD card capacity is from 1GB to 32GB (FAT).



SD Card

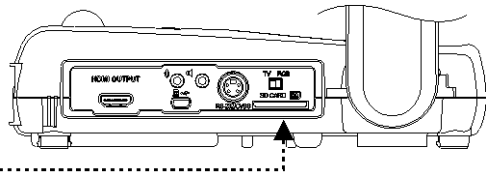

### Insert a USB Flash Drive

Make sure to set the USB Flash Drive switch (see *fig. 1.2 #1*) to the right before inserting a USB flash drive. AVerVision M70 can support USB flash drive from 2GB to 32GB (FAT).



USB Flash Drive

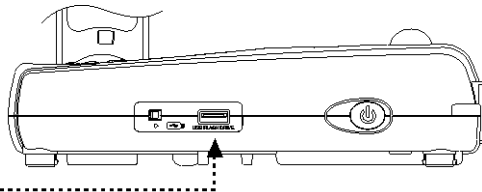

# OSD MENU

There are 4 tabs on the OSD menu: IMAGE, PRESENTATION, SETTING and SYSTEM. In Playback mode, you can access PLAYBACK OSD menu to enable the Slide Show feature and modify Slide Show interval and transition setting if desire.



For TV output, the RESOLUTION will be disabled in SETTING menu list.

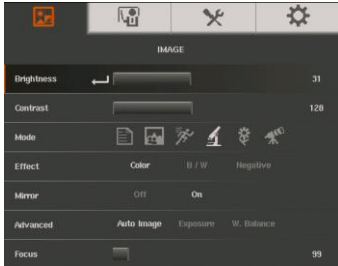

IMAGE

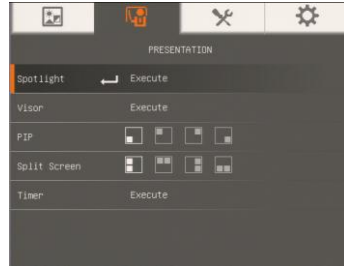

PRESENTATION

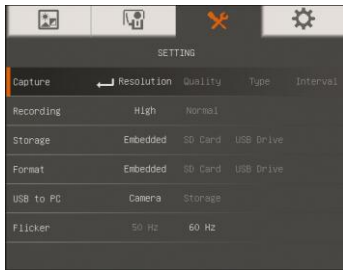

SETTING



SYSTEM

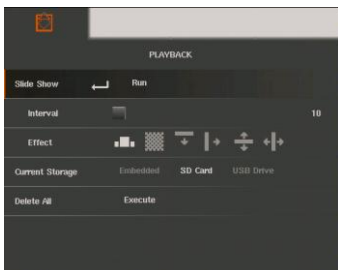

PLAYBACK



ANNOTATION

## Navigate the Menu and Submenu



1. Press MENU button on the remote or control panel.
2. Press ► and ◀ to toggle between tabs
3. Press ▼ and ▲ to choose a selection in the menu list.
4. Press ◀ to make a selection.
5. Use ► and ◀ to adjust the setting or make a selection.
6. Press ◀ to enter submenu.
7. Press MENU to close the OSD menu.

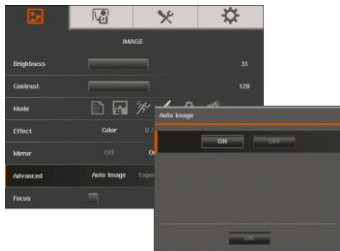

## Image

### Menu Screen

### Function

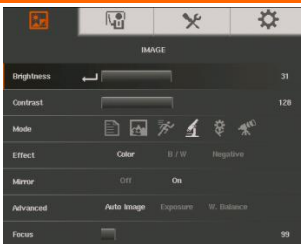

### Brightness

Adjust brightness level manually between 0 and 63.



### Contrast

Adjust the contrast level manually between 0 and 255 under bright and dark environments.



## Menu Screen





## Function

### Mode

Select from the various image display settings.

 **Sharp** - adjust the contrast along the edges making text appear more visible.

 **Graphics** - adjust the gradient of image.

 **Motion** - increase frame rate. Sufficient lighting is required when using this mode.

 **Microscope** - automatically adjust optical zoom for microscopic viewing.

 **Macro** - set to view when object is only 5 – 10 cm away from the camera.

 **Infinite** - set to view when subject is at least 80cm away from the camera.



### Effect

Convert the image into positive (true color), monochrome (black and white) or negative.

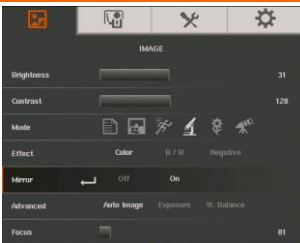

### Mirror

Select to flip the image in Camera mode.



### Advanced

Select to set the Auto Image, Exposure, and White Balance settings.

## Menu Screen

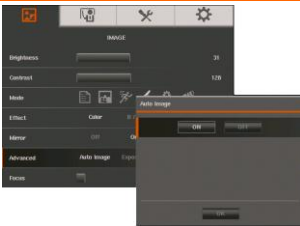

## Function

### Auto Image

Select ON or OFF to automatically adjust the white balance and exposure setting, and correct the color and exposure compensation.

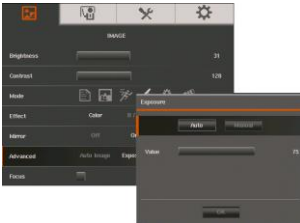

### Exposure

Select the exposure setting.

**AUTO** - automatically adjust the camera exposure and the amount of light required.

**MANUAL** - manually adjust the exposure level. The exposure can be adjusted up to 100.

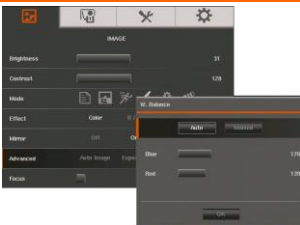

### White Balance

Select the White Balance setting for various light conditions or color temperature.

**AUTO** - automatically adjust the white balance.

**MANUAL** - manually adjust the red and blue color level. The color level can be adjusted up to 255.



### Focus

Manually adjust the focus.

# Presentation

## Menu Screen

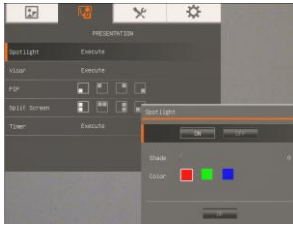

## Function

### Spotlight

Spotlight overlays a frame on the presentation screen. You can move the Spotlight around the presentation screen using the ▲, ▼, ◀, & ▶ buttons. Select Execute to call the Spotlight submenu.

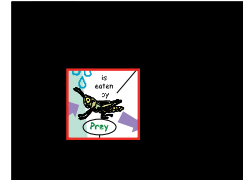



In the Spotlight submenu, the following options are available.

**ON/OFF** – select to run/cancel

the Spotlight. Press  to move to the next selection.

**Shade** – set the opacity level of the area outside the box. The shaded area will completely turn black when it is set to level 100. Press  to move to the next selection.

**Color** – select the Spotlight frame color. Press  to move to the next selection.

**OK** – press  for the setting to take effect. If you select ON, the frame will appear and blink, use the ▲, ▼, ◀, & ▶ buttons to adjust the frame size and press  to set the desired size; and OFF will close the submenu.

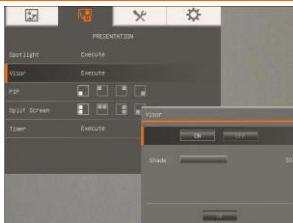

### Visor

Visor covers the presentation screen. The upper part of the presentation screen is slightly exposed. Use the ▲, ▼, ◀, & ▶ buttons to reveal more of the covered area. Select Execute to call the Visor submenu.

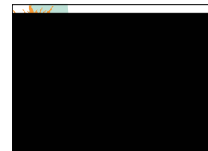

## Menu Screen

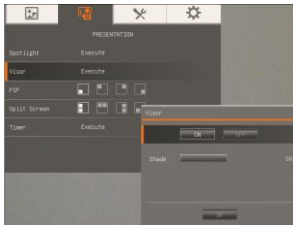



## Function

In the Visor submenu, the following options are available.



**ON/OFF** – select to run/cancel the Visor. Press  to move to the next selection.



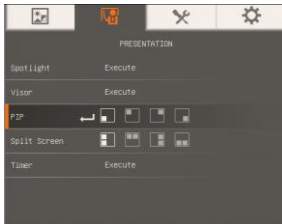

**Shade** – set the opacity level of the covered area. The shaded area will completely turns black when it is set to level 100. Press  to move to the next selection.

**OK** – press  for the setting to take effect. If you select ON, upper part of the presentation screen is slightly exposed. Use the ▲, ▼, ◀, & ▶ buttons to reveal more of the covered area; and OFF will close the submenu.



## PIP

Select the thumbnail playback screen location and show the thumbnail playback screen at the corner of the screen to recall the captured image from the memory in Camera mode. Select OFF to cancel PIP.

-  Lower Left
-  Upper Left
-  Upper Right
-  Lower Right

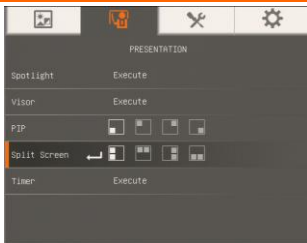

## Split Screen

Divide the screen into two parts. Half of the screen displays the 8-thumbnail images and the other half display the image from the AVerVision M70 camera.

Select the display location of the 8- thumbnail playback images. Select OFF to cancel Split Screen.

-  Left
-  Right
-  Top
-  Below

## Menu Screen

## Function

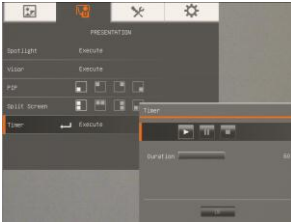

### Timer

Start/Pause/Stop the timer and set the timer duration. The timer automatically counts up after the count down reaches zero to show the elapsed time. Even when you switch between Playback, PC or Camera modes, the timer will continue.

## Setting

## Menu Screen

## Function

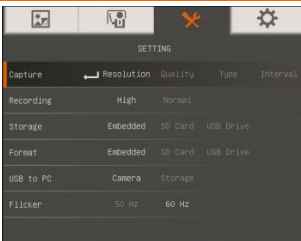

### Capture

Select to set the capture resolution, quality, type and interval settings.

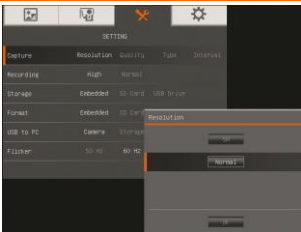

### Resolution

Select the capture size. In 5M setting, the capture resolution size is 2560 X 1920.

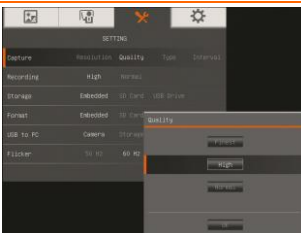

### Quality

Select the capture compression setting.

## Menu Screen

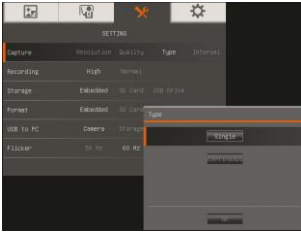

## Function

### Type

Select the capture type.

**Single** - capture one picture only.

**Continuous** - capture successive pictures.

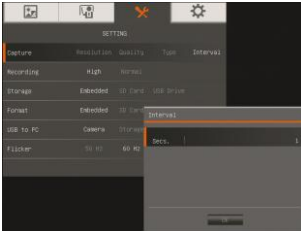

### Interval

Set the time interval for continuous capture. The length can be set up to 600 sec (10 min).

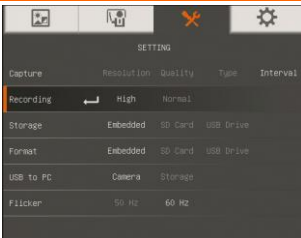

### Recording

Select the video recording compression setting.

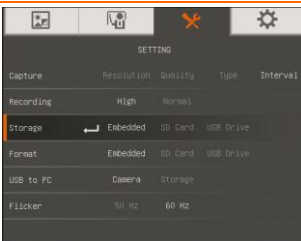

### Storage

Change the storage location. Audio & video recording can only be saved in SD memory card or USB flash drive.

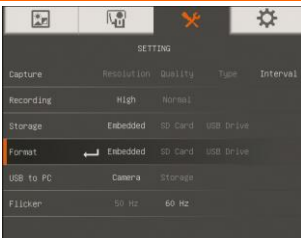

### Format

Format to delete all the data in the selected memory.

## Menu Screen

## Function

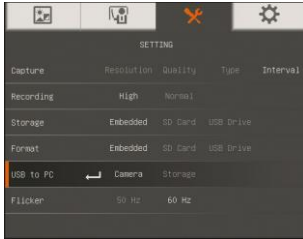

### USB to PC

Select the status of the AVerVision M70 when it is connected to the computer via USB. Make sure the USB switch on the left panel is set to .

**Camera** - can be used as a computer webcam or with our bundled software to record video and capture still image.

**Storage** - transfer the captured pictures/videos from the memory to computer hard disk.



### Flicker

Select between 50Hz or 60Hz. Some display devices cannot handle high refresh rates. The image will flicker a couple of times as the output is switched to another refresh rate.

## System

## Menu Screen

## Function

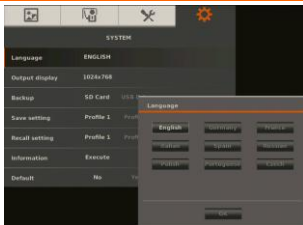

### Language

Change and select different language.

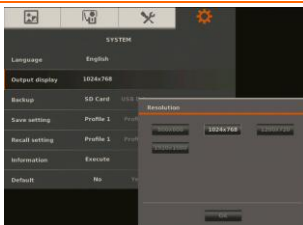

### Output Display

Set the resolution to display the image on screen. This selection will be disabled in TV output mode.

## Menu Screen

## Function



### Backup

Copy the image from the built-in memory to SD card or USB flash drive.

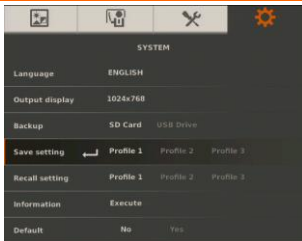

### Save Setting

Save current setting in the selected profile number. Only effect, mode, brightness and contrast settings can be saved.



### Recall Setting

Restore the setting back to the selected profile number.

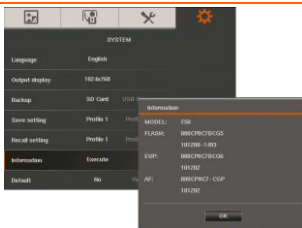

### Information

Display the product information.

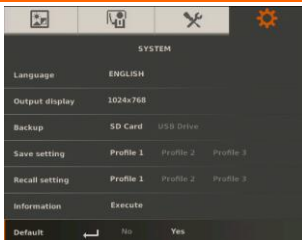

### Default

Restore all the settings into original factory default setting.



# Playback

## Menu Screen

## Function



### Slide Show

Display all captured still pictures in an automated slide show. The video file will be skipped.

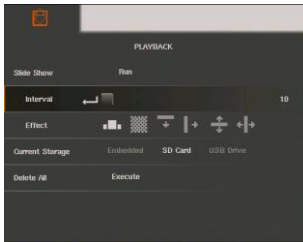

### Interval

Set the interval before displaying the next picture. The length can be set up to 100 sec.

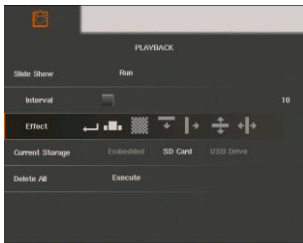

### Slide Show Effect

Select the slide show transition effect.



Slide image



Wipe right



Checker down



Split Vertical Out



Wipe down



Split Horizontal Out



### Current Storage

Select the source of the images.

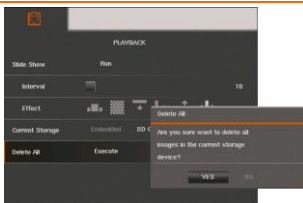

### Delete All

Permanently delete all the data in selected memory source. A Warning Message will appear. Select YES to continue and NO to stop formatting the storage.

## Annotation

In single image playback mode or when the screen is frozen in camera mode, you can use the annotation feature to overlay straight line or freeform line on the captured image or still camera screen with the USB mouse connected to the USB port of AVerVision M70. It comes with the following selections: Color Palette, Line Thickness, Line, Freehand, Capture, Eraser, and Hide/Show icons.



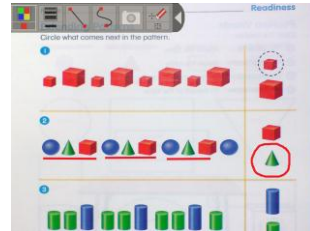

Annotation can only be supported in the following resolution setting :

- 1024 x 768
- 1280 x 720
- 1280 x 1024



## Connecting a USB mouse

1. Set the USB switch on the left panel to . AVerVision M70 will then detect the USB mouse and the  LED on the control panel will light up.

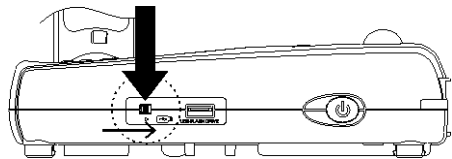



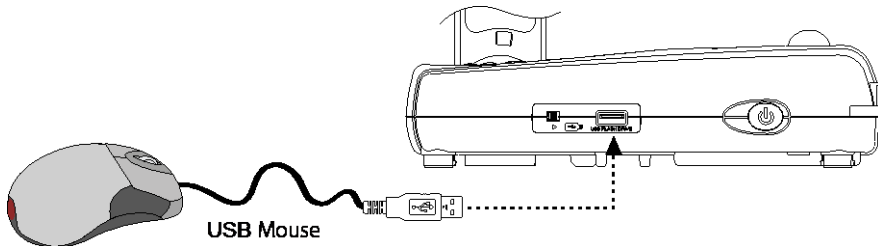



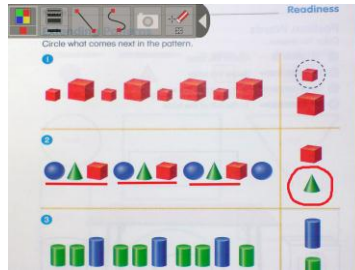

2. Connect the USB mouse cable to the USB slot of AVerVision M70.



## Using the Annotation Control Panel

The annotation control panel appears on the upper left corner of the screen. A cursor will appear on the screen. Move the cursor on the Annotation control panel selections and left-click to select the features you want to use.



Name	Function
 Color Palette	Select the line color.
 Line Thickness	Select the thickness of the line.
 Line	Select to draw a straight line.
 Freehand	Select to draw freeform line.
 Capture	Capture the image with the annotation and save it as a new file.
 Eraser	Select to erase any part of the annotation that it comes in contact with or delete all annotation.
 Hide/Show	Shrink or expand the annotation menu.

# Transfer Captured Images/Videos to a computer

This enables you to transfer the captured image from the built-in memory or SD to a computer.



The instruction below **MUST** be read and followed **BEFORE** connecting the USB cable.

1. Make sure to set the USB switch to **PC** for the computer to detect AVerVision M70.
2. **MUST** set the USB to PC as STORAGE before connecting the USB cable.
3. When **“Mass Storage Start...”** appears at the lower right corner of the presentation screen, you may now connect the USB cable.
4. Upon connecting the USB cable, the system automatically detects the new removable disk. You can now transfer the captured image(s) from the **UUM70 built-in memory** to the computer hard disk.

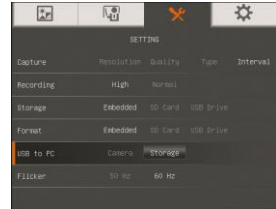

# Technical Specifications

## Image

Sensor	1/3.2" CMOS
Pixel Count	5 megapixels
Frame Rate	30 fps (max.)
White Balance	Auto / Manual
Exposure	Auto / Manual
Image mode	Sharp / Graphics / Motion / Microscope / Macro / Infinite
Effect	Color / B/W / Negative / Mirror / Rotate / Freeze
RGB output	1920x1080, 1600x1200, 1280x1024, 1280x720, 1024x768
HDMI output	HD 1080p; HD 720p
Image Capture	240 Frames(XGA) ; 80 Frames(5M Pixel)

## Optics

Focusing	Auto / Manual
Shooting Area	420mm x 315mm
Zooming	Total zoom 192X ( 12X Optical + 2X AVERZOOM™ +8X Digital Zoom)

## Power

Power Source	DC 12V, 100-240V, 50-60Hz
Consumption	16.8 Watts (lamp off); 18 Watts (lamp on)

## Lighting

Lamp Type	LED light
-----------	-----------

## Input/Output

RGB Input	15-Pins D-sub (VGA)
RGB Output	15-Pins D-sub (VGA)
HDMI Output	HDMI
CVBS/RS-232	Mini-DIN Jack (use CVBS/RS-232 Adapter cable_optional)
Composite Video	RCA Jack
USB	USB2.0
DC 12V Input	Power Jack
MIC	Phone Jack
Speaker	Phone Jack

## Dimension

Operating	452mm x 182mm x 504mm (+/-2mm include rubber foot)
Folded	367mm x 182mm x 63mm (+/-2mm include rubber foot)
Weight	2.1 kg (about 4.629 lbs)

## External Storage

Secure Digital (SD)	Max 32GB (FAT)
USB Flash Drive	Max 32GB (FAT)

## RS-232 Diagram Connection

AVerVision M70 can be controlled using a computer or any centralized control panel through RS-232 connection.

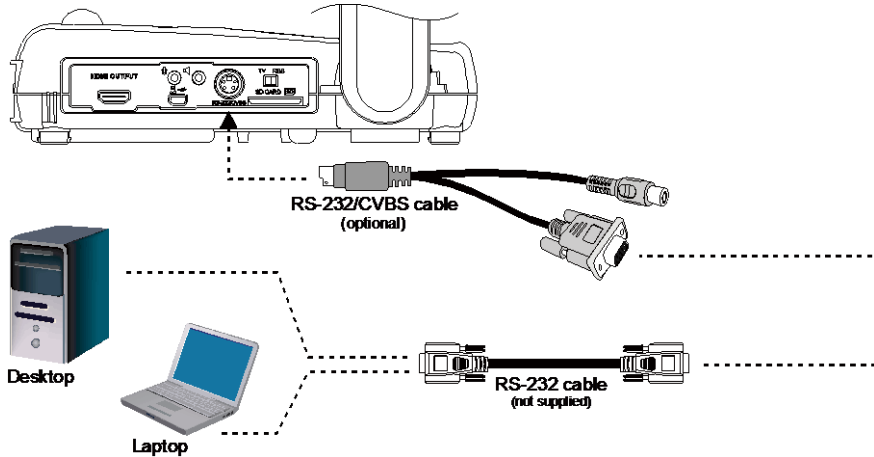

## RS-232 Cable Specifications

Make sure the RS-232 cable matches the cable specification design.

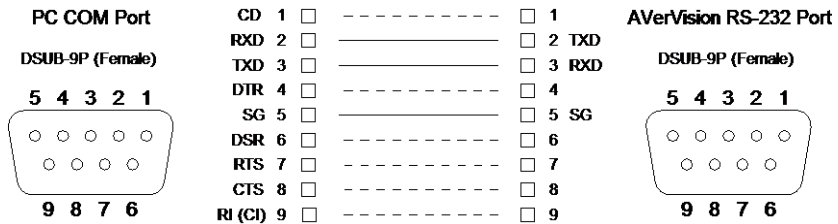

# RS-232 Transmission Specifications

- Start bit : 1 bit
- Data bit : 8 bit
- Stop bit : 1 bit
- Parity bit : None
- X parameter : None
- Baud rate (Communication speed) : 9600bps

## RS-232 Communication Format

Send Device Code(1 Byte) : 0x52  
 Type Code(1 Byte) : 0x0B  
 DataLength Code(1 Byte) : 0x03  
 Data Code(1 Byte) : See the Command Table for reference.  
 Data Code(2 Byte) : See the Command Table for reference.  
 Data Code(3 Byte) : See the Command Table for reference.  
 Receive Device Code(1 Byte) : 0x53  
 CheckSum Code(1 Byte) : See the Command Table for reference.  
 Format : Start + Type + DataLength + Data + CheckSum  
 Example : 0x52 + 0x0B + 0x03+ 0x01 + 0x00 + 0x00 + 0x53 + 0x5A  
 (Command Power Off)

## RS-232 Send Command Table

Send Format : 0x52 + 0x0B + 0x03 + Data[0] + Data[1] + Data[2] + 0x53 + CheckSum

Receive Format : 0x53 + 0x00 + 0x02+ \*2 + \*3 + 0x52 + CheckSum

\*1 : CheckSum = 0x0B xor 0x03 xor Data[0] xor Data[1] xor Data[2] xor 0x53

\*2 : Receive data ok : 0x0B, ID error: 0x01, CheckSum error: 0x02, Not Command : 0x03, Function fail = 0x04

\*3 : Data[0], Return 0x00 if error

Function	Data[0]	Data[1]	Data[2]	CheckSum
POWER OFF	0x01	0x00	0x00	0x5A
POWER ON	0x01	0x01	0x00	0x5B
CAMERA MODE	0x02	0x00	0x00	0x59
PLAYBACK MODE	0x03	0x00	0x00	0x58
PC-1 PASS THROUGH	0x04	0x00	0x00	0x5F
IMAGE CAPTURE TYPE: SINGLE	0x05	0x00	0x00	0x5E
IMAGE CAPTURE TYPE: CONTINUOUS	0x05	0x01	0x00	0x5F
CONT. CAPTURE INTERVAL +	0x06	0x00	0x00	0x5D

Function	Data[0]	Data[1]	Data[2]	CheckSum
CONT. CAPTURE INTERVAL -	0x06	0x01	0x00	0x5C
NORMAL IMAGE CAPTURE	0x07	0x00	0x00	0x5C
3M/5M IMAGE CAPTURE	0x07	0x01	0x00	0x5D
TIMER START	0x08	0x00	0x00	0x53
TIMER PAUSE	0x08	0x01	0x00	0x52
TIMER STOP	0x08	0x02	0x00	0x51
TIMER SET TIME	0x08	0x03	VALUE[ 1 ~ 120 ]	*1
PREVIEW MODE: SHARP	0x0A	0x00	0x00	0x51
PREVIEW MODE: GRAPHIC	0x0A	0x01	0x00	0x50
PREVIEW MODE: MOTION	0x0A	0x02	0x00	0x53
PREVIEW MODE: MICROSCOPE	0x0A	0x03	0x00	0x52
PREVIEW MODE: MACRO	0x0A	0x04	0x00	0x55
PREVIEW MODE: INFINITE	0x0A	0x05	0x00	0x54
PREVIEW MODE CAPTURE	0x0B	0x00	0x00	0x50
PLAYBACK DELETE	0x0C	0x00	0x00	0x57
PLAYBACK FULL SCREEN	0x0D	0x00	0x00	0x56
MIRROR OFF	0x0E	0x00	0x00	0x55
MIRROR ON	0x0E	0x01	0x00	0x54
ROTATE 0	0x0F	0x00	0x00	0x54
ROTATE 90	0x0F	0x01	0x00	0x55
ROTATE 180	0x0F	0x02	0x00	0x56
ROTATE 270	0x0F	0x03	0x00	0x57
EFFECT: COLOR	0x10	0x00	0x00	0x4B
EFFECT: B/W	0x10	0x01	0x00	0x4A
EFFECT: NEGATIVE	0x10	0x02	0x00	0x49
CONTRAST INCREASE	0x11	0x00	0x00	0x4A
CONTRAST DECREASE	0x11	0x01	0x00	0x4B
CONTRAST VALUE	0x11	0x02	VALUE[ 0 ~ 255 ]	*1
BRIGHTNESS INCREASE	0x12	0x00	0x00	0x49



Function	Data[0]	Data[1]	Data[2]	CheckSum
BRIGHTNESS DECREASE	0x12	0x01	0x00	0x48
BRIGHTNESS VALUE	0x12	0x02	VALUE[ 0 ~ 63 ]	*1
EXPOSURE: AUTO	0x13	0x00	0x00	0x48
EXPOSURE: MANUAL	0x13	0x01	0x00	0x49
EXPOSURE MANUAL INCREASE	0x14	0x00	0x00	0x4F
EXPOSURE MANUAL DECREASE	0x14	0x01	0x00	0x4E
WHITE BALANCE: AUTO	0x15	0x00	0x00	0x4E
WHITE BALANCE: MANUAL	0x15	0x01	0x00	0x4F
WHITE BALANCE BLUE INCREASE	0x16	0x00	0x00	0x4D
WHITE BALANCE BLUE DECREASE	0x16	0x01	0x00	0x4C
WHITE BALANCE RED INCREASE	0x17	0x00	0x00	0x4C
WHITE BALANCE RED DECREASE	0x17	0x01	0x00	0x4D
FLICKER: 50Hz	0x18	0x00	0x00	0x43
FLICKER: 60Hz	0x18	0x01	0x00	0x42
SPOTLIGHT: OFF	0x19	0x00	0x00	0x42
SPOTLIGHT: ON	0x19	0x01	0x00	0x43
SPOTLIGHT SHADE: 0% DARK	0x1A	0x00	0x00	0x41
SPOTLIGHT SHADE: 50% DARK	0x1A	0x01	0x00	0x40
SPOTLIGHT SHADE: 100% DARK	0x1A	0x02	0x00	0x43
SPOTLIGHT COLOR: RED	0x1B	0x00	0x00	0x40
SPOTLIGHT COLOR: GREEN	0x1B	0x01	0x00	0x41
SPOTLIGHT COLOR: BLUE	0x1B	0x02	0x00	0x42
SPOTLIGHT RESIZE	0x1C	0x00	0x00	0x47
VISOR: OFF	0x1D	0x00	0x00	0x46
VISOR: ON	0x1D	0x01	0x00	0x47
VISOR SHADE: 50% DARK	0x1E	0x00	0x00	0x45
VISOR SHADE: 100% DARK	0x1E	0x01	0x00	0x44
PIP: OFF	0x1F	0x00	0x00	0x44
PIP: ON	0x1F	0x01	0x00	0x45
PIP POSITION: BOTTOM LEFT	0x20	0x00	0x00	0x7B

Function	Data[0]	Data[1]	Data[2]	CheckSum
PIP POSITION: TOP LEFT	0x20	0x01	0x00	0x7A
PIP POSITION: TOP RIGHT	0x20	0x02	0x00	0x79
PIP POSITION: BOTTOM RIGHT	0x20	0x03	0x00	0x78
SPLITSCREEN: OFF	0x21	0x00	0x00	0x7A
SPLITSCREEN: ON	0x21	0x01	0x00	0x7B
SPLITSCREEN DIR: UPPER SCREEN	0x22	0x00	0x00	0x79
SPLITSCREEN DIR: LOWER SCREEN	0x22	0x01	0x00	0x78
SPLITSCREEN DIR: LEFT SCREEN	0x22	0x02	0x00	0x7B
SPLITSCREEN DIR: RIGHT SCREEN	0x22	0x03	0x00	0x7A
RECORDING: OFF	0x23	0x00	0x00	0x78
RECORDING: ON	0x23	0x01	0x00	0x79
MOVIE FAST REWIND	0x25	0x00	0x00	0x7E
MOVIE FAST FORWARD	0x25	0x01	0x00	0x7F
MOVIE VOL INC	0x26	0x00	0x00	0x7D
MOVIE VOL DEC	0x26	0x01	0x00	0x7C
RECORDING QUALITY: NORMAL	0x27	0x00	0x00	0x7C
RECORDING QUALITY: HIGH	0x27	0x01	0x00	0x7D
STORAGE: EMBEDDED	0x28	0x00	0x00	0x73
STORAGE: SD CARD	0x28	0x01	0x00	0x72
STORAGE: THUMB DRIVE	0x28	0x02	0x00	0x71
FORMAT: EMBEDDED	0x29	0x00	0x00	0x72
FORMAT: SD CARD	0x29	0x01	0x00	0x73
FORMAT: THUMB DRIVE	0x29	0x02	0x00	0x70
OUTPUT RESOLUTION: 1024x768	0x2F	0x01	0x00	0x75
OUTPUT RESOLUTION: 1280x720	0x2F	0x02	0x00	0x76
OUTPUT RESOLUTION: 1920x1080	0x2F	0x03	0x00	0x77
OUTPUT RESOLUTION: 1280x1024	0x2F	0x04	0x00	0x70
OUTPUT RESOLUTION: 1600x1200	0x2F	0x05	0x00	0x71
USB CONNECT: USB CAMERA	0x30	0x00	0x00	0x6B

Function	Data[0]	Data[1]	Data[2]	CheckSum
USB CONNECT: MASS STORAGE	0x30	0x01	0x00	0x6A
BACKUP TO SD CARD	0x31	0x00	0x00	0x6A
BACKUP TO THUMBDRIVE	0x31	0x01	0x00	0x6B
PROFILE SAVE: PROFILE 1	0x32	0x00	0x00	0x69
PROFILE SAVE: PROFILE 2	0x32	0x01	0x00	0x68
PROFILE SAVE: PROFILE 3	0x32	0x02	0x00	0x6B
PROFILE RECALL: PROFILE 1	0x33	0x00	0x00	0x68
PROFILE RECALL: PROFILE 2	0x33	0x01	0x00	0x69
PROFILE RECALL: PROFILE 3	0x33	0x02	0x00	0x6A
SLIDESHOW: OFF	0x34	0x00	0x00	0x6F
SLIDESHOW: ON	0x34	0x01	0x00	0x6E
SLIDESHOW EFFECT: EFFECT 0	0x35	0x00	0x00	0x6E
SLIDESHOW EFFECT: EFFECT 1	0x35	0x01	0x00	0x6F
SLIDESHOW EFFECT: EFFECT 2	0x35	0x02	0x00	0x6C
SLIDESHOW EFFECT: EFFECT 3	0x35	0x03	0x00	0x6D
SLIDESHOW EFFECT: EFFECT 4	0x35	0x04	0x00	0x6A
SLIDESHOW EFFECT: EFFECT 5	0x35	0x05	0x00	0x6B
AUTO IMAGE:OFF	0x36	0x00	0x00	0x6D
AUTO IMAGE:ON	0x36	0x01	0x00	0x6C
CAPTURE QUALITY: NORMAL	0x37	0x00	0x00	0x6C
CAPTURE QUALITY: HIGH	0x37	0x01	0x00	0x6D
CAPTURE QUALITY: FINEST	0x37	0x02	0x00	0x6E
AUTO FOCUS	0x40	0x00	0x00	0x1B
MENU	0x41	0x00	0x00	0x1A
ARROW - DOWN	0x42	0x00	0x00	0x19
ARROW - UP	0x42	0x01	0x00	0x18
ARROW - LEFT	0x42	0x02	0x00	0x1B
ARROW - RIGHT	0x42	0x03	0x00	0x1A
ENTER	0x43	0x00	0x00	0x18
FREEZE	0x44	0x00	0x00	0x1F

Function	Data[0]	Data[1]	Data[2]	Checksum
DEFAULT	0x45	0x00	0x00	0x1E
ZOOM -	0x46	0x00	0x00	0x1D
ZOOM +	0x46	0x01	0x00	0x1C
ZOOM RESET	0x47	0x00	0x00	0x1C
NEAR	0x48	0x00	0x00	0x13
FAR	0x48	0x01	0x00	0x12
LAMP OFF	0x49	0x00	0x00	0x12
LAMP ON	0x49	0x01	0x00	0x13

## RS-232 Get Command Table

Send Format : 0x52 + 0x0A + 0x01 + Data[0] + 0x53 + CheckSum

Receive Format : 0x53 + 0x0C + 0x01 + ReData[0] + 0x53 + ReCheckSum

\*1 : ReCheckSum = 0x0C xor 0x01 xor ReData[0] xor 0x52.

Function	Data[0]	Checksum Code	ReData[0]
RED VALUE	0x02	0x5A	VALUE[ 0 ~ 255 ]
BLUE VALUE	0x03	0x5B	VALUE[ 0 ~ 255 ]
POWER STATUS	0x04	0x5C	0 : OFF 1: ON
LAMP STATUS	0x05	0x5D	0 : OFF 1: ON
DISPLAY STATUS	0x06	0x5E	0: CAMERA MODE 1: PLAYBACK MODE 2: PC-1 PASS THROUGH
VIDEO OUTPUT STATUS	0x07	0x5F	0: VGA 1: TV
FREEZE STATUS	0x08	0x50	0 : OFF 1: ON
BRIGHTNESS VALUE	0x0A	0x52	VALUE[ 0 ~ 63 ]
CONTRAST VALUE	0x0B	0x53	VALUE[ 0 ~ 255 ]

# Troubleshooting

This section provides many useful tips on how to solve common problems while using the AVerVision M70.

## **There is no picture on the presentation screen.**

1. Check all the connectors again as shown in this manual.
2. Check the on/off switch of the display output device.
3. Verify the setting of the display output device.
4. If you are presenting from a notebook or computer through the display output device, check the cable connection from computer RGB (VGA) output to RGB input of AVerVision M70 and make sure AVerVision M70 is in PC Mode.
5. For HDMI display output, a delay occurs while waiting for both the display device and M70 to sync up. Wait for around 4 to 7 seconds until you see the camera image on the screen.

## **I have set up the AVerVision M70 and checked all the connections as specified in the manual but I cannot get a picture on the preferred presentation screen.**

1. The unit POWER button turns orange in standby mode. Press the POWER button again to turn on and the LED light will turn blue.
2. The default camera display resolution setting is on 1024x768. If your output device does not support this resolution; no image can be projected. Simply press hold the FREEZE and ► button to the change the resolution setting.
3. If your display output device is on TV or any analog device, please switch the TV-RGB dip switch to TV.

## **The picture on the presentation screen is distorted or the image is blurry.**

1. Reset all changed settings, if any, to the original manufacturer default setting. Press **DEFAULT** on the remote or select Default in Basic tab OSD menu.
2. Use the Brightness and Contrast menu functions to reduce the distortion if applicable.
3. If you discover that the image is blurry or out of focus, press the Auto Focus button on the control panel or remote control.

## **There is no computer signal on presentation screen.**

1. Check all the cable connections among the display device, AVerVision M70 and your PC.
2. Connect your PC to the AVerVision M70 first before you power on your computer.
3. For notebook, repeatedly press FN+F5 to toggles between display modes and display the computer image on the presentation screen. For different command, please refer to your laptop manual.

## **The presentation screen does not show the exact desktop image on my PC or Notebook after I toggle from Camera to PC mode.**

1. Return to your PC or Notebook, place the mouse on the desktop and right click, choose "Properties", choose "Setting" tab, click on "2" monitor and check the box "Extend my Windows desktop onto this monitor".
2. Then go back one more time to your PC or Notebook and place the mouse on the desktop and right click again.
3. This time choose "Graphics Options", then "Output To", then "Intel® Dual Display Clone", and then choose "Monitor + Notebook".
4. After you follow these steps, you should be able to see the same desktop image on your PC or Notebook as well as on the presentation screen.

**AVerVision M70 can't detect the inserted USB flash drive.**

Make sure the USB flash drive switch is set to the right and check if the USB flash drive is properly inserted.

**The recorded video on MAC with the bundled software doesn't have sound.**

Due to some limitation, we recommend recording the audio directly from the MAC MIC IN port for better audio quality.

## **Limited Warranty**

For a period of time beginning on the date of purchase of the applicable product and extending as set forth in the “**Warranty Period of AVer Product Purchased**” section of the warranty card, AVer Information, Inc. (“AVer”) warrants that the applicable product (“Product”) substantially conforms to AVer’s documentation for the product and that its manufacture and components are free of defects in material and workmanship under normal use. “You” as used in this agreement means you individually or the business entity on whose behalf you use or install the product, as applicable. This limited warranty extends only to You as the original purchaser. Except for the foregoing, the Product is provided “AS IS.” In no event does AVer warrant that You will be able to operate the Product without problems or interruptions, or that the Product is suitable for your purposes. Your exclusive remedy and the entire liability of AVer under this paragraph shall be, at AVer’s option, the repair or replacement of the Product with the same or a comparable product. This warranty does not apply to (a) any Product on which the serial number has been defaced, modified, or removed, or (b) cartons, cases, batteries, cabinets, tapes, or accessories used with this product. This warranty does not apply to any Product that has suffered damage, deterioration or malfunction due to (a) accident, abuse, misuse, neglect, fire, water, lightning, or other acts of nature, commercial or industrial use, unauthorized product modification or failure to follow instructions included with the Product, (b) misapplication of service by someone other than the manufacturer’s representative, (c) any shipment damages (such claims must be made with the carrier), or (d) any other causes that do not relate to a Product defect. The Warranty Period of any repaired or replaced Product shall be the longer of (a) the original Warranty Period or (b) thirty (30) days from the date of delivery of the repaired or replaced product.

### **Limitations of Warranty**

AVer makes no warranties to any third party. You are responsible for all claims, damages, settlements, expenses, and attorneys’ fees with respect to claims made against You as a result of Your use or misuse of the Product. This warranty applies only if the Product is installed, operated, maintained, and used in accordance with AVer specifications. Specifically, the warranties do not extend to any failure caused by (i) accident, unusual physical, electrical, or electromagnetic stress, neglect or misuse, (ii) fluctuations in electrical power beyond AVer specifications, (iii) use of the Product with any accessories or options not furnished by AVer or its authorized agents, or (iv) installation, alteration, or repair of the Product by anyone other than AVer or its authorized agents.

### **Disclaimer of Warranty**

EXCEPT AS EXPRESSLY PROVIDED OTHERWISE HEREIN AND TO THE MAXIMUM EXTENT PERMITTED BY APPLICABLE LAW, AVER DISCLAIMS ALL OTHER WARRANTIES WITH RESPECT TO THE PRODUCT, WHETHER EXPRESS, IMPLIED, STATUTORY OR OTHERWISE, INCLUDING WITHOUT LIMITATION, SATISFACTORY QUALITY, COURSE OF DEALING, TRADE USAGE OR PRACTICE OR THE IMPLIED WARRANTIES OF MERCHANTABILITY, FITNESS FOR A PARTICULAR PURPOSE OR NONINFRINGEMENT OF THIRD PARTY RIGHTS.

### **Limitation of Liability**

IN NO EVENT SHALL AVER BE LIABLE FOR INDIRECT, INCIDENTAL, SPECIAL, EXEMPLARY, PUNITIVE, OR CONSEQUENTIAL DAMAGES OF ANY NATURE INCLUDING, BUT NOT LIMITED TO, LOSS OF PROFITS, DATA, REVENUE, PRODUCTION, OR USE, BUSINESS INTERRUPTION, OR PROCUREMENT OF SUBSTITUTE GOODS OR SERVICES ARISING OUT OF OR IN CONNECTION WITH THIS LIMITED WARRANTY, OR THE USE OR PERFORMANCE OF ANY PRODUCT, WHETHER BASED ON CONTRACT OR TORT, INCLUDING NEGLIGENCE, OR ANY OTHER LEGAL THEORY, EVEN IF AVER HAS ADVISED OF THE POSSIBILITY OF SUCH DAMAGES. AVER'S TOTAL, AGGREGATE LIABILITY FOR DAMAGES OF ANY NATURE, REGARDLESS OF FORM OF ACTION, SHALL IN NO EVENT EXCEED THE AMOUNT PAID BY YOU TO AVER FOR THE SPECIFIC PRODUCT UPON WHICH LIABILITY IS BASED.

### **Governing Law and Your Rights**

This warranty gives you specific legal rights; You may also have other rights granted under state law. These rights vary from state to state.



For warranty period, please refer to the warranty card.

---