

# E36c+v

## User Manual







# WARNING

# AVERTISSEMENT

**ALWAYS FOLLOW SAFETY PRECAUTIONS**

**RESPECTEZ TOUJOURS LES CONSIGNES DE SÉCURITÉ**

- Death or serious injury may occur when children climb on audio and/or video equipment furniture. A remote control or toys placed on the furnishing may encourage a child to climb on the furnishing and as a result the furnishing may tip over on to the child.
- Relocating audio and/or video equipment to furniture not specifically designed to support audio and/or video equipment may result in death or serious injury due to the furnishing collapsing or over turning onto a child.
- Il y a un danger de blessures graves ou même de mort si un enfant grimpe sur un meuble pour matériels audio ou vidéo. Une télécommande ou un jouet laissés sur le meuble peuvent inciter l'enfant à y grimper, ce qui peut provoquer le basculement du meuble sur l'enfant.
- Le repositionnement de matériels audio ou vidéo sur un meuble non spécialement conçu pour cela peut causer la mort ou des blessures graves par effondrement ou renversement du meuble sur un enfant.

To reduce risk  
of electric shock  
**ONLY** use indoors.

Pour réduire le risque de  
décharge électrique, n'utilisez  
le chariot **QU'À L'INTÉRIEUR.**

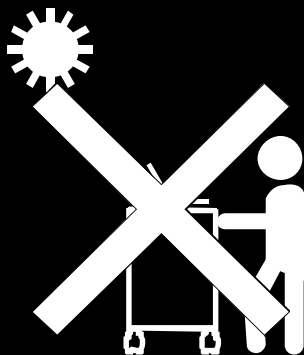

**ONLY ADULTS** should  
move the cart.

Le chariot ne doit être déplacé  
**QUE PAR DES ADULTES.**



**NEVER** climb, sit  
or stand on the cart.

Personne ne doit s'asseoir,  
se tenir ou grimper sur  
le chariot.

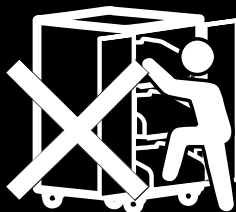

### **⚠ CAUTION**

This cart is intended for use only with loading as indicated. Use with loads greater than indicated may result in instability causing possible injury.

### **⚠ MISE EN GARDE**

Ce chariot est conçu pour  
n'être utilisé qu'avec des charges  
telles qu'indiquées. L'utilisation  
avec des charges supérieures aux  
indiquées peut rendre le chariot  
instable et causer des blessures.

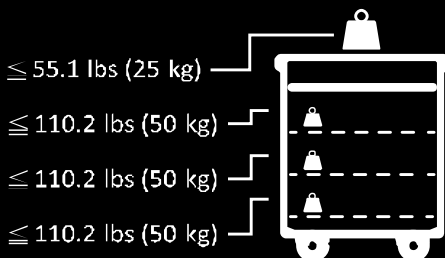

Please load the devices from the bottom to top shelf to avoid the tilting.  
Chargez les étagères en commençant par celle du bas pour éviter le basculement.

## CAUTION

- **DO NOT** allow anyone to sit, stand or climb on the cart.
- **DO NOT** lift the cart.
- **DO NOT** block the ventilation holes used for air circulation.
- **DO NOT** overload objects on the cart shelves. (work platform maximum loading = 25kg / 55.1lbs; each shelf maximum loading = 50kg / 110.2lbs).
- **DO NOT** put any devices over the maximum loading weight on top of the cart.
- When moving the cart, **DO NOT** put any devices (ex: TV, Monitor, Documents camera...etc.) on top of cart.
- **DO NOT** use a TV/monitor on top of the cart.
- Disconnect the power from the outlet before moving the cart.
- While moving the cart, make sure the power cord is secured and tightly wrapped.
- When moving carts over uneven flooring, please try to slightly lift and stabilize the cart to avoid damage.

## ATTENTION !

- **PERSONNE** ne doit s'asseoir, se tenir ou grimper sur le chariot.
- **IL NE FAUT PAS** soulever le chariot.
- **IL NE FAUT PAS** obstruer les orifices de ventilation qui permettent à l'air de circuler.
- **IL NE FAUT PAS** surcharger d'objets les étagères du chariot (charge maximale de la plateforme de travail : 25 kg / 55,1 lbs ; charge maximale de chaque étagère : 50 kg / 110,2 lbs).
- **IL NE FAUT PAS** poser sur le haut du chariot des appareils dont le poids dépasse la charge maximale.
- Pour déplacer le chariot, **IL NE FAUT** poser aucun appareil (poste de TV, moniteur, caméra pour documents, etc.) sur le haut dudit chariot.
- N'utilisez aucun téléviseur ni moniteur sur le haut du chariot.
- Avant de déplacer le chariot, débranchez la prise secteur.
- Pendant le déplacement du chariot, veillez à ce que le cordon d'alimentation soit correctement replié et fixé.
- Lorsque vous déplacez des chariots sur un sol inégal, merci d'essayer de le soulever légèrement et de le stabiliser pour éviter les dégâts.

## Federal Communications Commission Statement



NOTE: This equipment has been tested and found to comply with the limits for a Class A digital device, pursuant to part 15 of the FCC Rules. These limits are designed to provide reasonable protection against harmful interference when the equipment is operating in a commercial environment. This equipment generates, uses, and can radiate radio-frequency energy and, if not installed and used in accordance with the instruction manual, may cause harmful interference to radio communications. Operation of this equipment in a residential area is likely to cause harmful interference in which case the user will be required to correct the interference at his own expense.

**FCC Caution:** Any changes or modifications not expressly approved by the party responsible for compliance could void the user's authority to operate this equipment.

This device complies with part 15 of the FCC Rules.

The operation is subject to the following two conditions:

- (1) This device may not cause harmful interference, and
- (2) this device must accept any interference received, including interference that may cause undesired operation.

## European Community Compliance Statement (Class A)



This product is herewith confirmed to comply with the requirements set out in the Council Directives on the Approximation of the laws of the Member States relating to Electromagnetic Compatibility Directive 2014/30/EU.

**Warning** - This is a Class A product. In a domestic environment, this product may cause radio interference in which case the user may be required to take adequate measures to correct this interference.

## **DISCLAIMER**

No warranty or representation, either expressed or implied, is made with respect to the contents of this documentation, its quality, performance, merchantability, or fitness for a particular purpose. Information presented in this documentation has been carefully checked for reliability; however, no responsibility is assumed for inaccuracies. The information contained in this documentation is subject to change without notice.

In no event will AVer Information Inc. be liable for direct, indirect, special, incidental, or consequential damages arising out of the use or inability to use this product or documentation, even if advised of the possibility of such damages.

## **TRADEMARKS**

“AVer” is a trademark owned by AVer Information Inc. Other trademarks used herein for description purpose only belong to each of their companies.

## **COPYRIGHT**

©2021 AVer Information Inc. All rights reserved.

All rights of this object belong to AVer Information Inc. Reproduced or transmitted in any form or by any means without the prior written permission of AVer Information Inc. is prohibited. All information or specifications are subject to change without prior notice.



The mark of Crossed-out wheeled bin indicates that this product must not be disposed of with your other household waste. Instead, you need to dispose of the waste equipment by handing it over to a designated collection point for the recycling of waste electrical and electronic equipment. For more information about where to drop off your waste equipment for recycling, please contact your household waste disposal service or the shop where you purchased the product.





# Contents

<b>INTRODUCTION .....</b>	<b>1</b>
Package Contents .....	1
Dimensions .....	1
Diagram .....	2
Front.....	2
Side.....	2
Back.....	3
Door Lock .....	4
<b>INSTALLATION .....</b>	<b>5</b>
Back.....	5
Front.....	8
<b>CHARGING THE CART .....</b>	<b>9</b>
<b>SPECIFICATIONS .....</b>	<b>10</b>
<b>TROUBLESHOOTING .....</b>	<b>11</b>
<b>SERVICE AND WARRANTY.....</b>	<b>11</b>



# Introduction

The E36c+v cart can store and charge up to 36 Chromebooks, laptops or tablets with up to a 15" screen.

## Package Contents

The following items are included in the package. Please check if each item is available before using.

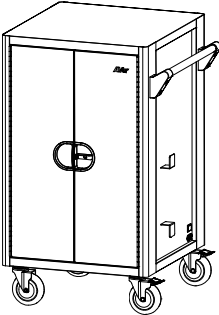

**E36c+v Cart**



**User Manual**

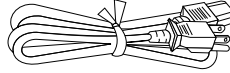

**Power Cord**

## Dimensions

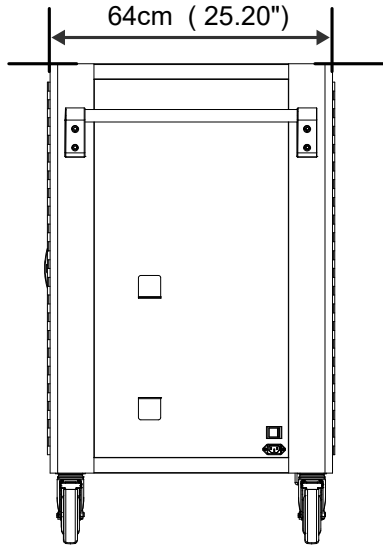
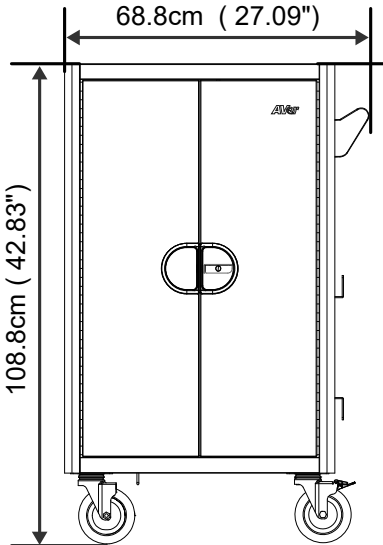

# Diagram

## Front

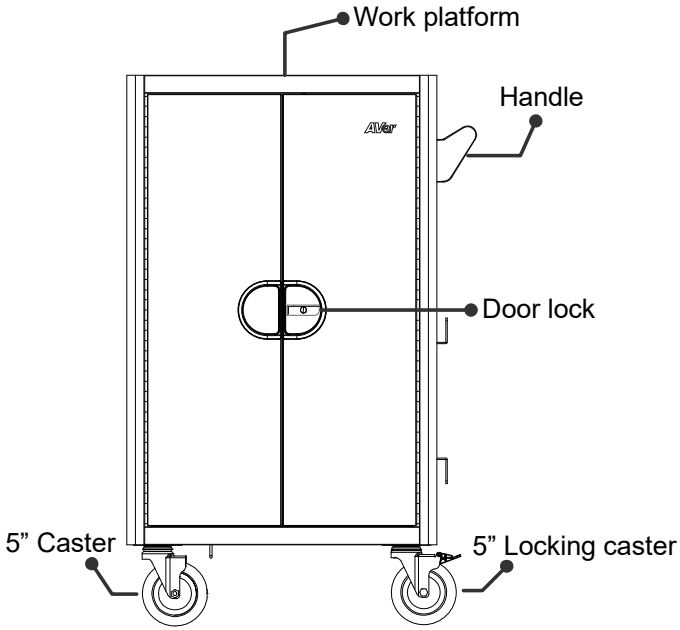

## Side

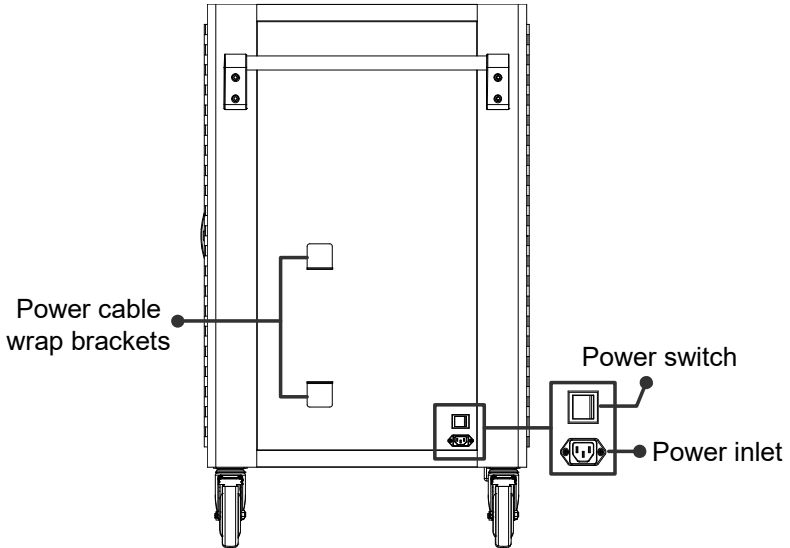

# Back

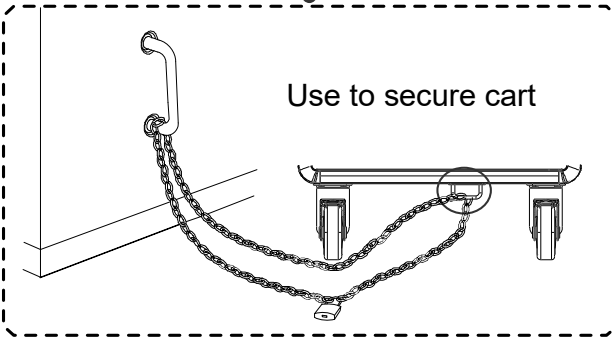
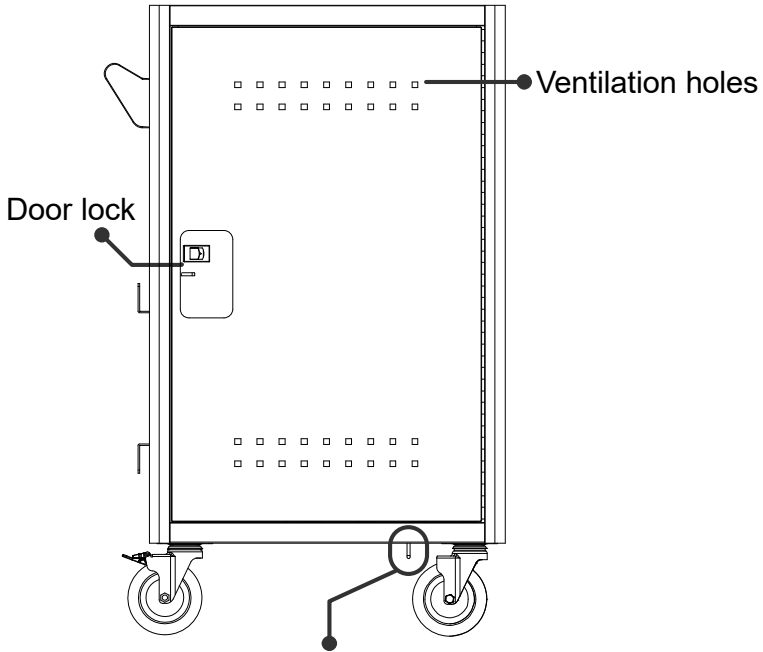

# Door Lock

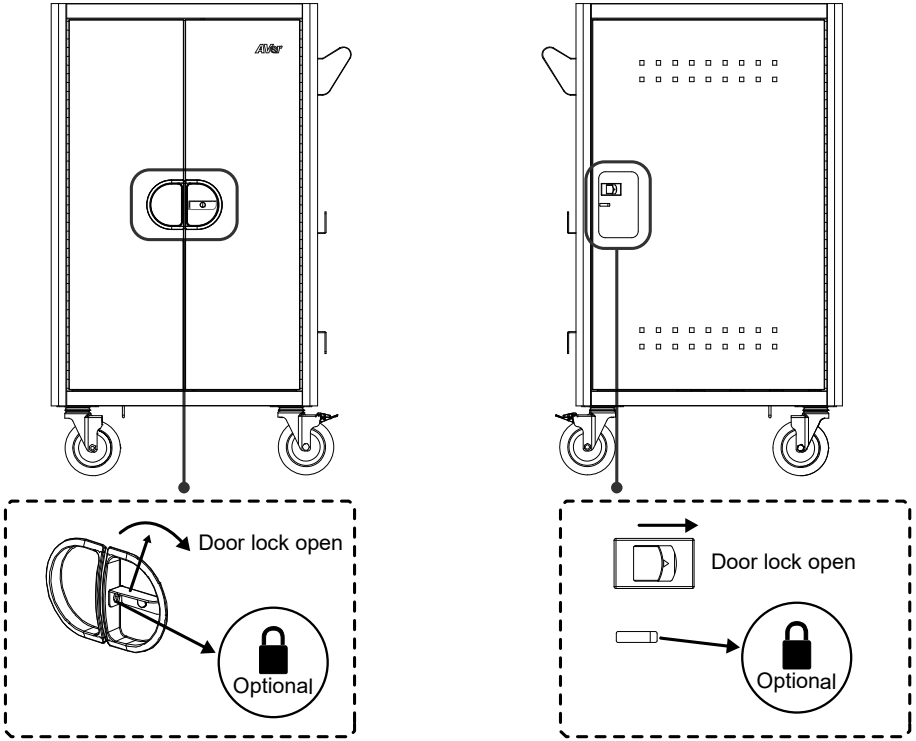

**[Note]** The shackle dimension of front and back doors are limited to Ø8mm (0.31”).

# Installation

## Back

1. Open the door on the back side.
2. Place the device power adapter brick to the adapter holder.
3. Plug-in AC-end power plug of device to the power AC socket on the cart.

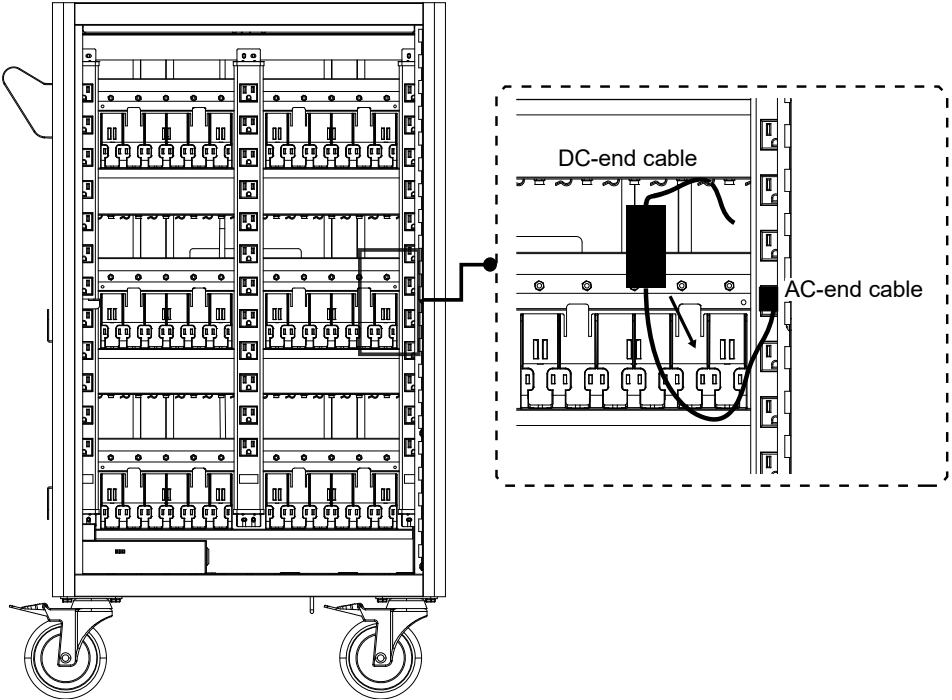

### [Note]

- It is recommended to use cable ties (optional) to secure and manage cables.
- It is recommended to allocate 2 persons for efficient device cabling.

4. With the front door opened and route the cable through front cable hook groove respectively.

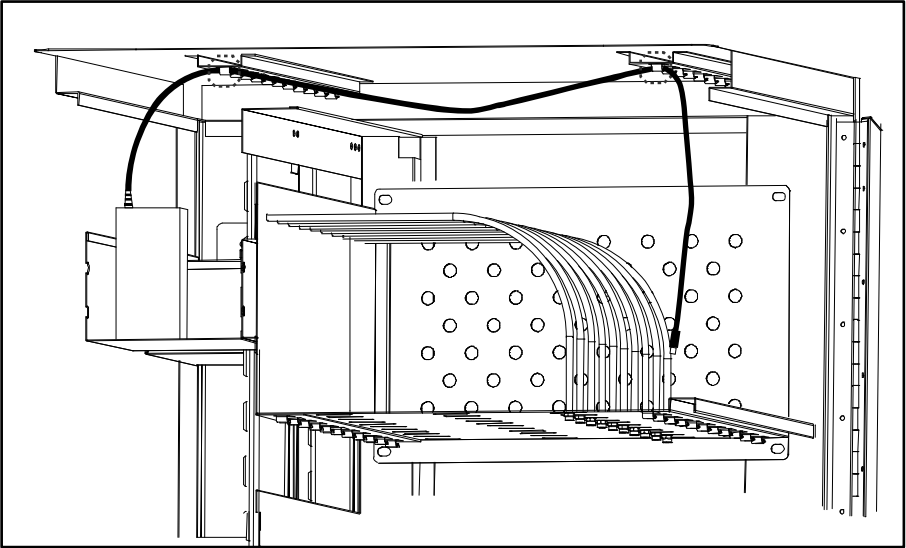

**[Note]** For smaller cables you may want to press the end of the cable hook to secure the cable from falling out.

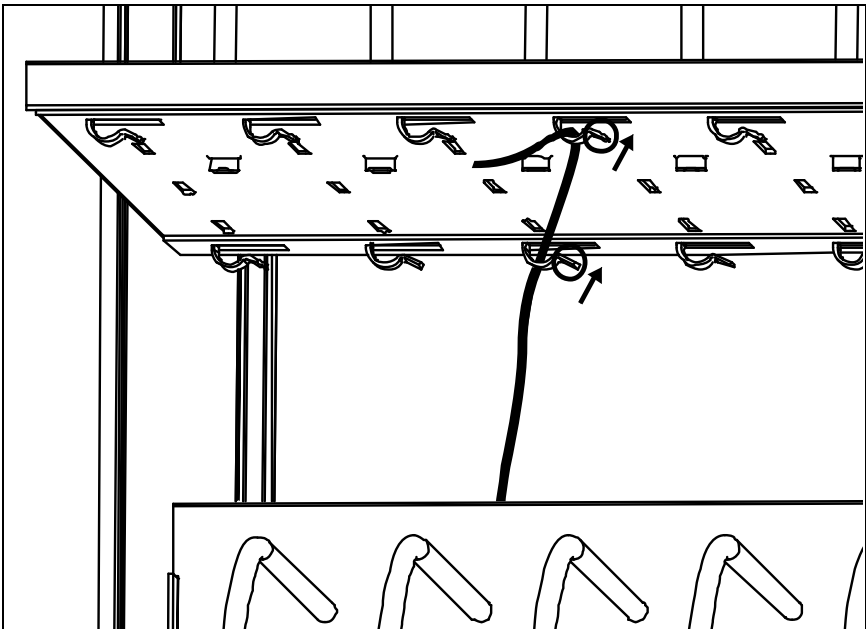



## [Smart Cycle Charging]

1. The Smart cycle charging in the E36c+v will begin charging the 1st power strip and alternate every 20 minutes to each power strip.
2. If the charging zone has only one or two devices and the electrical demand is less than 0.5A, then the system will automatically skip to the next charging zone.
3. If the electrical demand of entire cart is less than 8A, then the system will charge all devices simultaneously instead of cycling between the three zones.

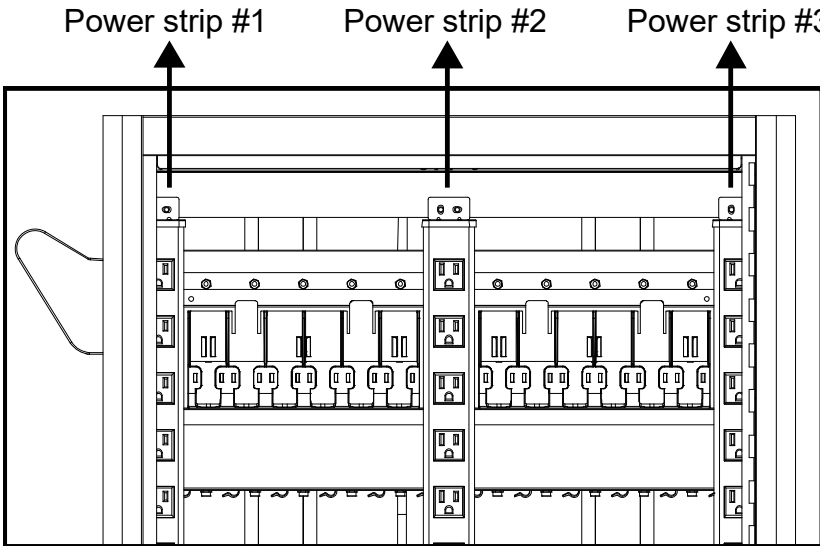

## Front

1. Open the front doors.
2. Put the device (Chromebook, tablet, etc.) into the bay.

Put the device into the bay

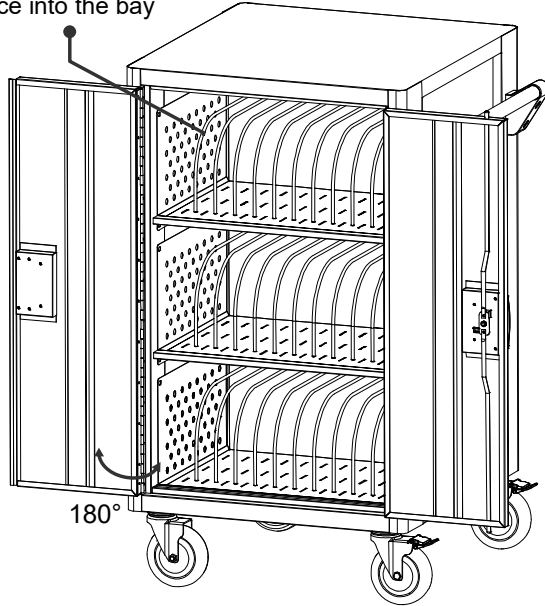

3. Connect the power jack to the device.

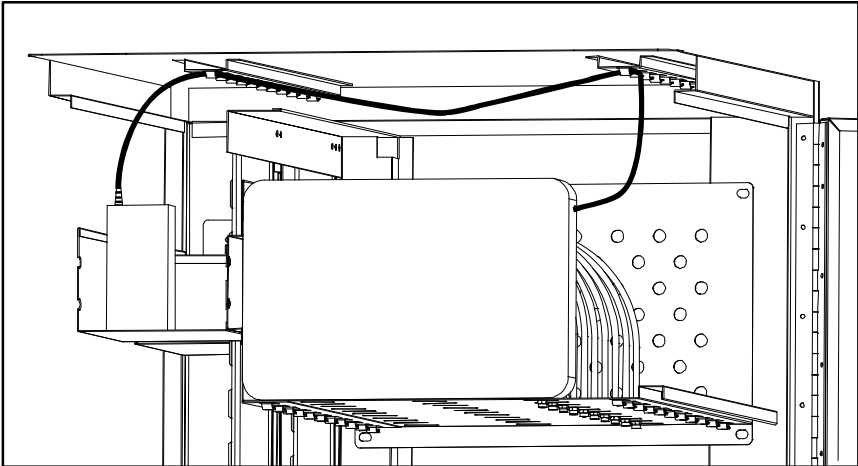

**[Note]** Close the front doors before moving the cart to prevent devices from falling out.

# Charging the Cart

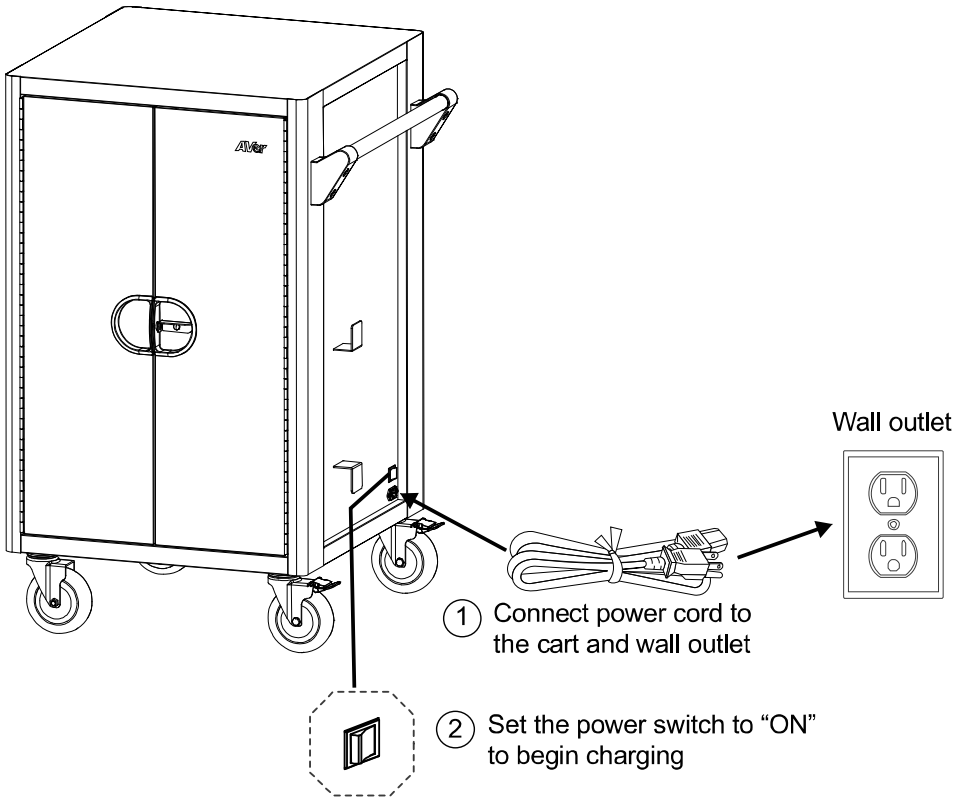

**[Note]** Set the power switch to the **OFF** position before plugging the cart to wall outlet.

# Specifications

<b>Model</b>	E36c+v
<b>Capacity</b>	36 (three shelves, 12 bays per shelf)
<b>Supported Devices</b>	Mobile devices up to 15"
<b>Charging Type</b>	Smart Cycle Charging
<b>Power Specification</b>	AC IN: 100-120V ~ 50/60Hz, 12A Power Strip: 100-120V ~ 50/60Hz, 12A
<b>Security</b>	Front doors: 3 point mechanism with lock hole
<b>Casters</b>	Four 5" casters; two are lockable
<b>Work Platform Loading</b>	25kg (55.1lbs)
<b>Shelf Loading(ea.)</b>	50kg (110.2lbs)
<b>Adapter Shelves Loading(ea.)</b>	3kg(6.6lbs)
<b>Working Temperature</b>	0°~30°C
<b>Working RH%</b>	10%~90%
<b>Storage Temperature</b>	-40°C~60°C
<b>Storage RH%</b>	5%~95%
<b>Warranty</b>	10 years cart and tray 5 years electrical components
<b>Cart Dimensions (W x D x H)</b>	688(W) x 640(D) x 1088 (H) mm 27.09"(W) x 25.20"(D) x 42.83"(H)
<b>Slot Dimensions (W x D x H)</b>	32(W) x 380(D) x 260(H) mm 1.26"(W) x 14.96"(D) x 10.24"(H)
<b>Weight without Devices</b>	60kg (132.3lbs)

# Troubleshooting

**Q: Why are all of my devices plugged in but not charging?**

- A:
1. Make sure power cords are undamaged.
  2. Make sure power cords are firmly inserted into the available socket with stable current.
  3. Make sure the power plug and current consumption are compliant with your country specification standards.

**Q: My cart's main power cord or cart components are damaged. Are they covered under warranty?**

A: We provide a 10 year warranty on the cart and tray, and 5 years warranty on the electrical components.

**Q: How do I know if my devices will exceed more than the allotted current?**

A: Have a qualified electrician verify the current consumption of your devices. Perform the test with devices installed and batteries discharged.

**Q: When I plug in the device it trips the circuit breaker. What is wrong?**

A: You may have other equipment or appliances sharing the same circuit that is causing a circuit overload. Have a qualified electrician check that adequate power is available in the circuit.

**Q: My power cords are not staying in the provided cable clips when the cart is moving, how can I resolve this?**

A: For smaller power cords, try pressing the end of the cable hook to close the gap once your cable is securely in place. Be sure to only close the cable hook just enough to prevent the cable from falling out.

## SERVICE AND WARRANTY

All of our products come with a quality and safety assurance.

For customers located in North America, please visit the AVer USA support site for comprehensive RMA, Warranty, and Service information:

<http://averusa.com/classroom-technology/support/>

For customers located outside North America, please visit AVer Global support site: <http://www.aver.com/>





