

VB370A

4K Dual Lens Video Bar

— User Manual —

Federal Communication Commission Interference Statement

NOTE: This equipment has been tested and found to comply with the limits for a Class A digital device, pursuant to part 15 of the FCC Rules. These limits are designed to provide reasonable protection against harmful interference when the equipment is operated in a commercial environment. This equipment generates, uses, and can radiate radiofrequency energy and, if not installed and used in accordance with the instruction manual, may cause harmful interference to radio communications. Operation of this equipment in a residential area is likely to cause harmful interference in which case the user will be required to correct the interference at his own expense.

FCC Caution: Any changes or modifications not expressly approved by the party responsible for compliance could void the user's authority to operate this equipment.

This device complies with part 15 of the FCC Rules.

The Operation is subject to the following two conditions:

- (1) This device may not cause harmful interference, and
- (2) this device must accept any interference received, including interference that may cause undesired operation.

This Class A digital apparatus complies with Canadian ICES-003. Cet appareil numérique de la classe A est conforme à la norme NMB-003 du Canada.

Warning

This is a class A product. In a domestic environment this product may cause radio interference in which case the user may be required to take adequate measures.

Caution

Risk of explosion if battery is replaced by an incorrect Type. Dispose of used batteries according to the Instructions.

PSTI Statement of Compliance

Please refer to the following website: <https://www.aver.com/product-security-advisory>

VCCI-A

この装置はクラス A 機器です。この装置を住宅環境で使用すると電波妨害を引き起こすことがあります。この場合には使用者が適切な対策を講ずるよう要求されることがあります。

(注) 本製品同梱の電源ケーブルは本製品同梱の電源アダプタでのみ使用してください。本製品同梱の電源ケーブルは他の電気機器では使用できません。

사 용 자 안 내 문	
이 기기는 업무용 환경에서 사용할 목적으로 적합성평가를 받은 기기로서 가정용 환경에서 사용하는 경우 전자파간섭의 우려가 있습니다.	
※ 사용자 안내문은 "업무용 방송통신기자재"에만 적용됩니다.	

기종별	사용자안내문
A 급 기기 (업무용 방송통신기자재)	이 기기는 업무용(A 급) 전자파적합기기로서 판매자 또는 사용자는 이 점을 주의하시기 바라며, 가정외의 지역에서 사용하는 것을 목적으로 합니다.

DISCLAIMER

No warranty or representation, either expressed or implied, is made with respect to the contents of this documentation, its quality, performance, merchantability, or fitness for a particular purpose. Information presented in this documentation has been carefully checked for reliability; however, no responsibility is assumed for inaccuracies. The information contained in this documentation is subject to change without notice.

In no event will AVer Information Inc. be liable for direct, indirect, special, incidental, or consequential damages arising out of the use or inability to use this product or documentation, even if advised of the possibility of such damages.

TRADEMARKS

“AVer” is a trademark owned by AVer Information Inc. Other trademarks used herein for description purpose only belong to each of their companies.

COPYRIGHT

©2024 AVer Information Inc. All rights reserved. | November 6, 2024

All rights of this object belong to AVer Information Inc. Reproduced or transmitted in any form or by any means without the prior written permission of AVer Information Inc. is prohibited. All information or specifications are subject to change without prior notice.

More Help

For FAQs, technical support, software and user manual download, please visit:

Non-USA

Download Center: <https://www.aver.com/download-center>

Technical Support: <https://www.aver.com/technical-support>

USA

Download Center: <https://www.averusa.com/business/support/>

Technical Support: <https://averusa.force.com/support/s/contactsupport>

Contact Information

Headquarters

AVer Information Inc.
8F, No.157, Da-An Rd.,
Tucheng Dist., New Taipei City
23673, Taiwan
Tel: +886 (2) 2269 8535

USA Branch Office

AVer Information Inc.,
Americas
44061 Nobel Drive, Fremont,
CA 94538, USA
Tel: +1 (408) 263 3828
Toll-free: +1 (877) 528 7824

Europe Branch Office

AVer Information Europe B.V.
Westblaak 134, 3012 KM,
Rotterdam, The Netherlands
Tel: +31 (0) 10 7600 550

Japan Branch Office

アバー・インフォメーション株式会社
〒160-0023 日本東京都新宿区
西新宿 3-2-26 立花新宿ビル
7 階
Tel: +81 (0) 3 5989 0290
お客様サポートセンター(固定電
話のみ): +81 (0) 120 008 382

Vietnam Branch Office

Công ty TNHH AVer
Information
(Việt Nam)
Tầng 5, 596 Nguyễn Đình
Chiều, P.3, Quận 3, Thành phố
Hồ Chí Minh 700000, Việt
Nam
Tel: +84 (0) 28 22 539 211
Hỗ trợ kỹ thuật: +84 (0) 90 70
080 77

Korea Office

한국 에버 인포메이션 (주)
서울시 종로구 새문안로 92
(신문로 1가,
광화문오피시아빌딩) 1831,
1832 호
Tel: +82 (0) 2 722 8535

Contents

Overview	1
Package Contents	1
Optional Accessories	1
Parts Info	2
LED Indicators	3
Remote Control	4
Connections.....	5
Device Connection.....	5
Installation	8
Wall Mount Installation.....	8
TV VESA Mount Installation (Optional).....	9
Start a Meeting in Zoom Rooms.....	11
Pair VB370A with a Controller	11
Sign In to Zoom Rooms.....	12
As the owner, admin, or user	12
With an activation code.....	13
Share Content in Zoom Rooms	15
Use HDMI	15
Use Zoom App or Browser	16
Android Interface.....	17
Access the Android Interface	17
Setting Page	18
PTZ Control	19
Save, Load and Clear a Preset.....	20
Firmware Update	21
Setting	22
Audio	24

Network	26
System.....	27
Video Service Provider	28
Web Interface	29
Access the Web Interface.....	29
AVer IP Finder.....	29
PTZ Control	31
Overview of PTZ Control.....	31
Save and Load a Preset	32
Setting	33
Overview of the Floating Live View	35
Network	36
System.....	37
Audio	39

Overview

Package Contents



Video Bar

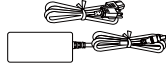

Power Adapter &
Power Cord

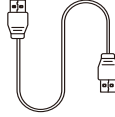

HDMI 2.0 Cable



Remote Control



AAA Battery
(x2, US only)

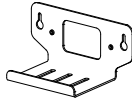

Wall Mount Bracket



1/4"-20 L=7.5 mm
Screw (x2)



Drill Template

Optional Accessories

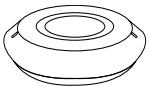

Expansion
Speakerphone
10 m / 20 m w/ Cable



Expansion
Microphone
10 m / 20 m w/ Cable



CP10 G2
Collaboration
Controller

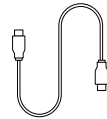

USB 3.0 Type-C to C
Cable (2 m)

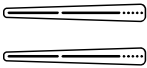

TV VESA Mount

Parts Info

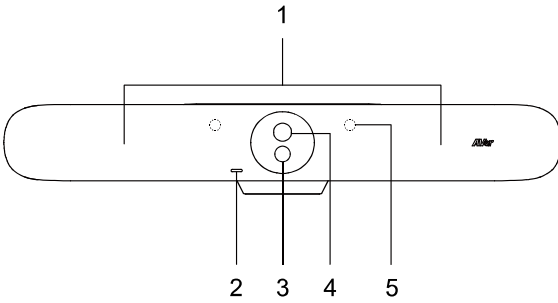

- 1. Beamforming Microphones
- 2. LED Indicator
- 3. Wide-Angle Lens
- 4. Optical Zoom Lens
- 5. IR Sensors

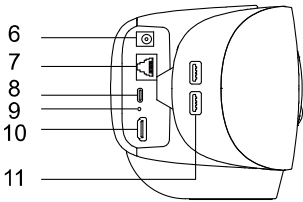

- 6. DC Power Jack
- 7. Ethernet Port
- 8. N/A
- 9. Reset Hole
- 10. HDMI In Port
- 11. USB 3.0 Type-A Port (x2)

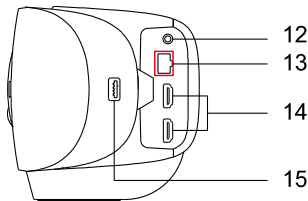

- 12. Phone In Port
- 13. Audio Expansion Port (red)
- 14. HDMI Out Ports (x2)
- 15. N/A

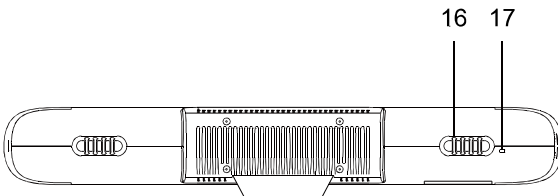

- 16. Cable Retention
- 17. Kensington Lock

LED Indicators

Color	Status
Solid red	Start-up
Solid white	Standby
Solid blue	Streaming
Solid red	Microphone muted
Solid orange	Sleep Mode

Remote Control

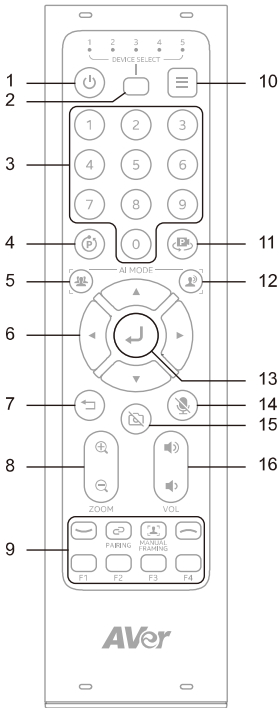

Name	Function
1. Power	N/A
2. Camera Select	N/A
3. Number Buttons	<ul style="list-style-type: none"> To save a preset: Press and hold a Number (0-9). To load a preset: Press a Number (0-9).
4. Compound Key	N/A
5. SmartFrame	<ul style="list-style-type: none"> Press to frame entire group on screen. Press and hold to cycle through tracking modes (Manual Frame > Auto Frame > AI Off).
6. Directional Buttons	Pan and tilt direction control.
7. Back	N/A
8. Zoom In/Out	Zoom in or out.
9. Function Buttons	N/A*
10. Menu	N/A
11. Load Preset	With each press, cycle through defined presets.
12. Audio Tracking	Press and hold to cycle through audio tracking modes (Audio Tracking > Audio Frame+ > Presentation Mode > Audio Fence > AI Off).
13. Enter	Press to display current AI function on closed caption.
14. Mute	N/A
15. Camera Off	N/A*
16. Volume	Volume up or down.

* Pending release.

For the most updated information, please refer to the release note from AVer Download Center.

Connections

Device Connection

- Left Panel

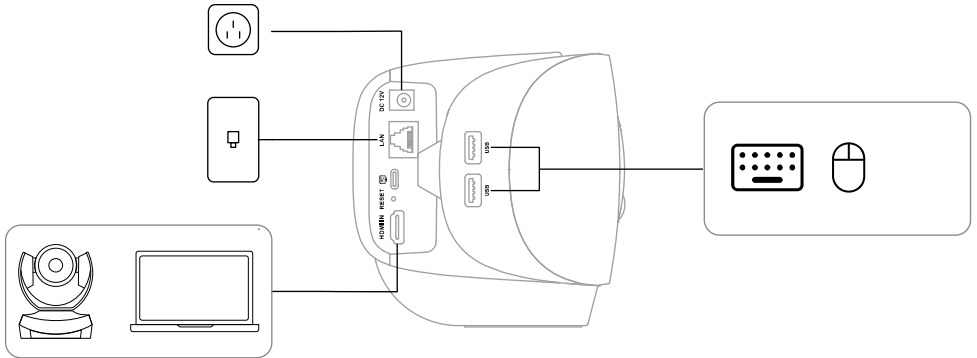

Port	Description
DC Power Jack	Connect to a power source using the included power adapter and power cord.
Ethernet Port	Connect to an Ethernet port to access Zoom Rooms or the device web interface. Note: The VB370A and the paired iPad, tablet or purpose-built controller, such as CP10 G2, must be connected to the same local area network (LAN)
PC (USB 3.0 Type-A) Port	N/A*
Reset Hole	Insert a paper clip and hold for 3 seconds to reboot.
HDMI In Port	Connect to a second camera or computer to share content in Zoom Rooms.
USB 3.0 Type-A Port (x2)	Connect peripheral devices, such as a keyboard or mouse to navigate the Android interface.

* Pending release.

For the most updated information, please refer to the release note from AVer Download Center.

- **Right Panel**

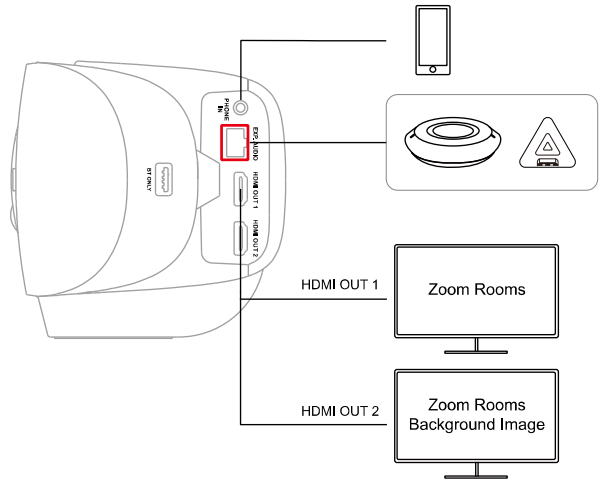

Note: If you have multiple displays, you can change how they're arranged by doing one of the following:

- On Zoom Rooms Controller, start or join a meeting > tap **View** > select a layout.
- Sign in to the Zoom web portal as the account owner, admin, or user with access to Zoom Rooms. Go to **Room Management** > **Zoom Rooms** > **Display**.

Port	Description
Phone In Port	Connect to a mobile phone and use the VB370A as an external speakerphone.
Audio Expansion Port (red)	Connect to an expansion speakerphone or expansion microphone. Note: <ul style="list-style-type: none"> • The expansion speakerphone and expansion microphone are optional accessories. • Daisy-chain connection is not supported.
HDMI Out 1 Port	Connect to a monitor to display a pairing code for the Zoom Rooms Controller application.
HDMI Out 2 Port	Connect to a second monitor to display shared content in a Zoom Room. This monitor displays a Zoom Rooms background image in absence of shared content or an additional camera feed.
Bluetooth® Port	N/A*

* Pending release.

For the most updated information, please refer to the release note from AVer Download Center.

- **CP10 G2**



Installation

Wall Mount Installation

1. Use the wall mount drilling template to mark and drill the mounting holes on the wall.
2. Insert 2 screws and plastic anchors (not included) to the wall.
 - Concrete wall: M5 x20mm self-tapping screws (x2) + plastic anchors (x2)
 - Wooden wall: M5 x20mm self-tapping screws (x2)
3. Secure the wall mount bracket with the supplied 2 tripod screws to the bottom of the camera.

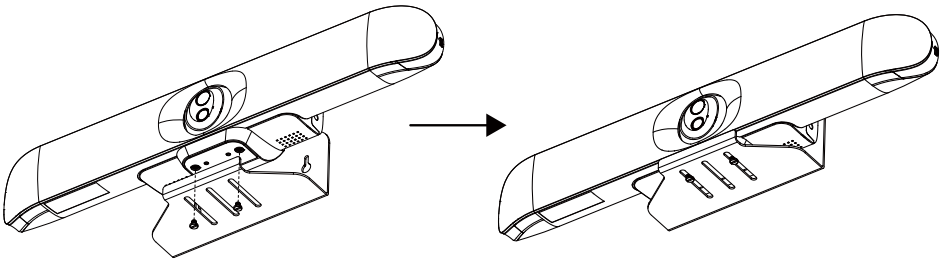

4. Position the camera with the inserted screws on the wall.

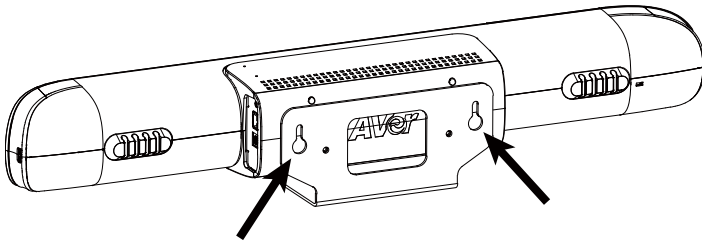

TV VESA Mount Installation (Optional)

• Package Contents



- | | |
|------------------|---------------------|
| Screw(M5*10) x 2 | Silicone washer x 2 |
| Screw(M6*15) x 4 | Metal washer x 2 |
| Screw(M6*20) x 4 | Washer(M6) x 4 |
| Screw(M8*20) x 4 | Washer(M8) x 4 |
| Screw(M8*30) x 4 | |

The VB370A can be installed the same way on top of or under the TV.

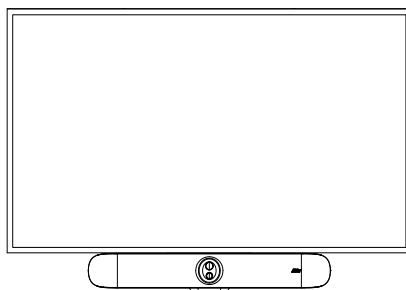
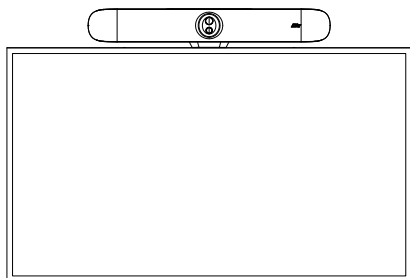

1. Fix the screw (M5*10) with silicone washer in suitable holes (1~5).
2. Slightly fix the fixture on the rear side of the camera. You may choose which screw hole to use for fixing it.

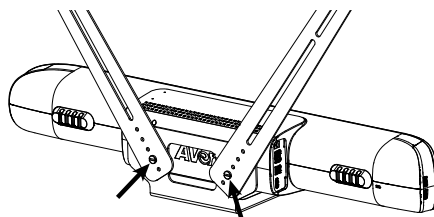
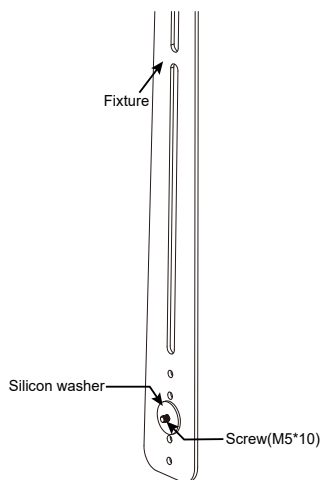

3. Place the metal washers on the mount holes of TV. If you don't need to install TV mount rack, skip step 3—5.

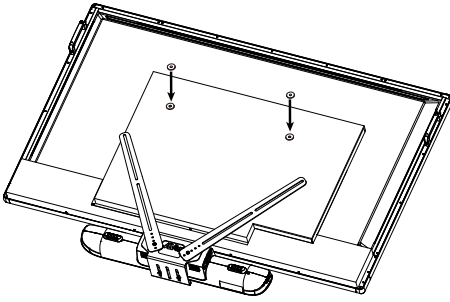

4. Place the TV mount rack on top of the fixtures.

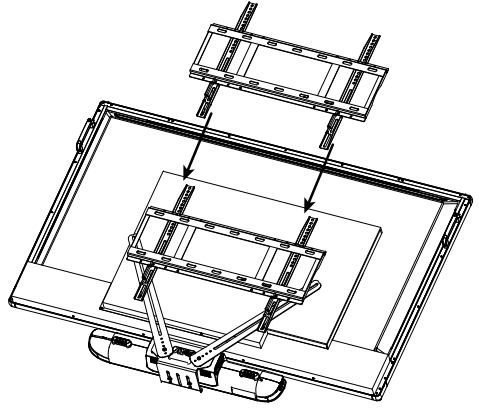

5. Slightly secure the mount rack and fixture on the TV. Adjust the position if needed and then secure tight the screws.

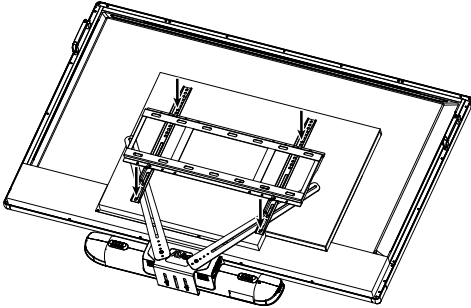

6. If you don't need to install TV mount rack, slightly secure the fixture on the TV and adjust the position if needed. Finally, tightly screw all screws.

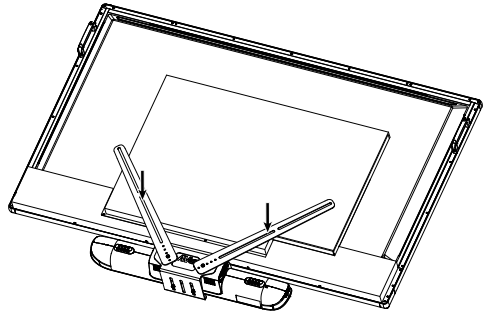

Start a Meeting in Zoom Rooms

Pair VB370A with a Controller

Connect your VB370A Android video bar to an iPad, tablet or purpose-built controller, such as CP10 G2. VB370A and CP10 G2 are pre-installed with Zoom Rooms software.

1. Make sure VB370A and CP10 G2 are connected to the same local area network (LAN).
2. Connect a monitor to the HDMI out 1 port on VB370A using the included HDMI cable. The monitor will display a pairing code.

Note: For first time use, follow the on-screen instructions to set up system language, country or region, and time zone.

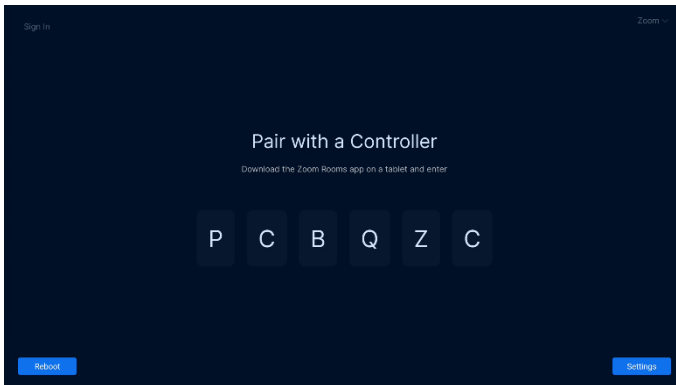

3. Open the Zoom Rooms application on the controller, then select **Zoom Rooms Controller**.

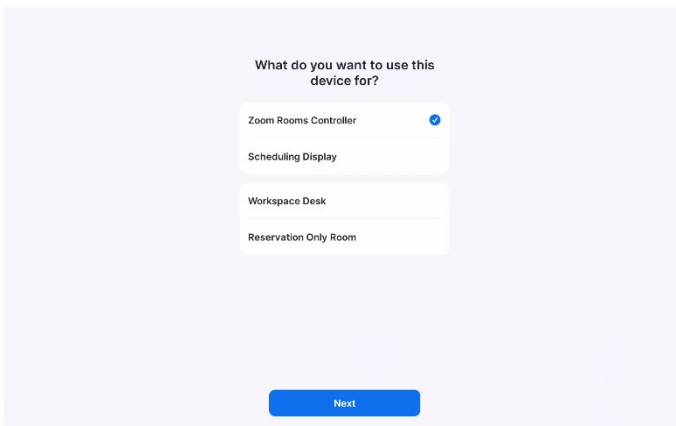

4. Enter the pairing code on the controller.

Your Zoom Room will now be available to launch a test meeting or join a meeting.

Sign In to Zoom Rooms

To deploy a full Zoom Room, your account must include Zoom Room licenses or a free 30-day trial of Zoom Rooms.

As the owner, admin, or user

1. Make sure you have paired VB370A with a controller.
2. On the Zoom Rooms Controller, tap **Sign In**.

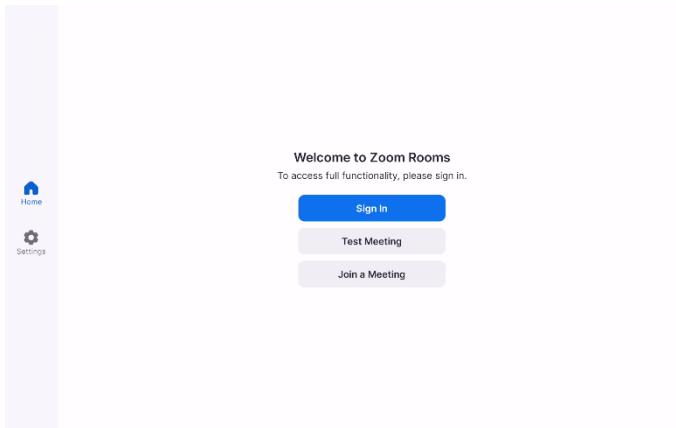

3. Sign in as the account owner, admin, or user with access to Zoom Rooms.

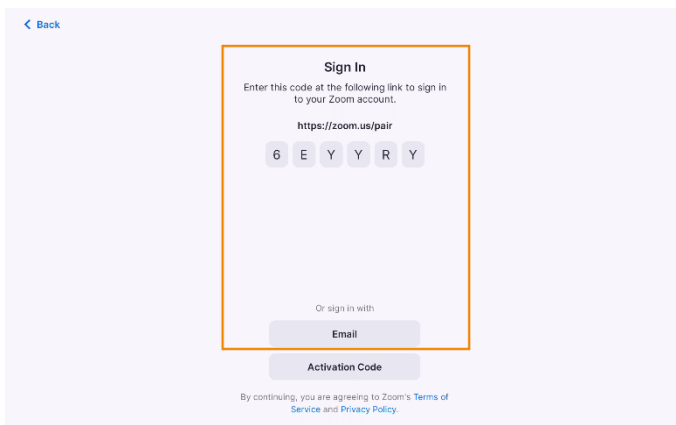

4. Tap the name of this Zoom Room or add a new room from the controller.
5. The VB370A and controller will now be signed in.

With an activation code

An activation code is generated after setting up the Zoom Room on the web portal. Using the activation code is ideal when the person deploying Zoom Rooms is not the administrator.

1. Make sure you have paired VB370A with a controller.
2. Sign in to the Zoom web portal as the account owner, admin, or user with access to Zoom Rooms.
3. Create the Zoom Room in the web portal.
If the Zoom Room has already been created, in the navigation panel, click **Room Management**, then **Zoom Rooms**.
4. Find the **Activation Code** column for the Zoom Room and take note of the number.

Note: An email will be sent to the Account Owner, with the Activation Code as well.

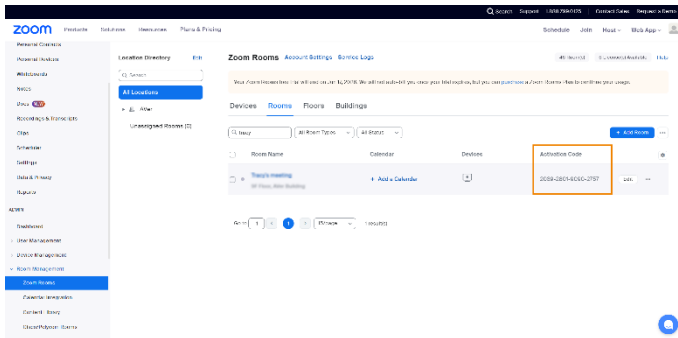

5. Open the Zoom Rooms application on the controller.

6. On the Zoom Rooms Controller, tap **Enter Activation Code**.

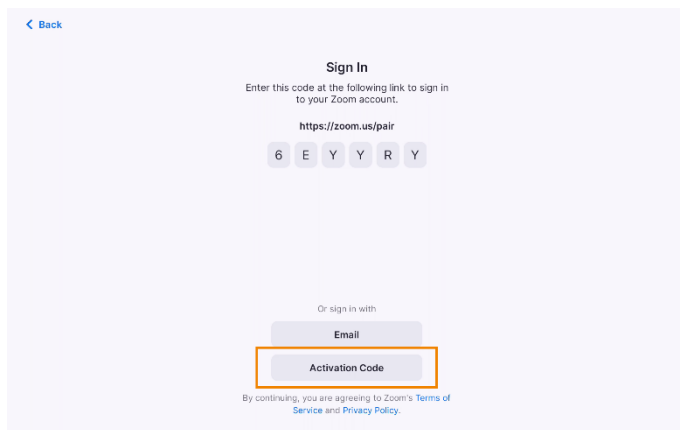

7. Enter the Activation Code, found on your web portal or emailed to you.
8. The VB370A and controller will now be signed in.

Share Content in Zoom Rooms

VB370A can share a second camera or your screen from a computer.

Use HDMI

1. Connect your second camera or your computer to the HDMI in port on VB370A.
2. On the Zoom Rooms Controller, start or join a meeting.
3. Tap **Share Content** > **Share to Meeting**. Or tap **HDMI**.
Your second camera feed or desktop will be shared to the Zoom Room display.

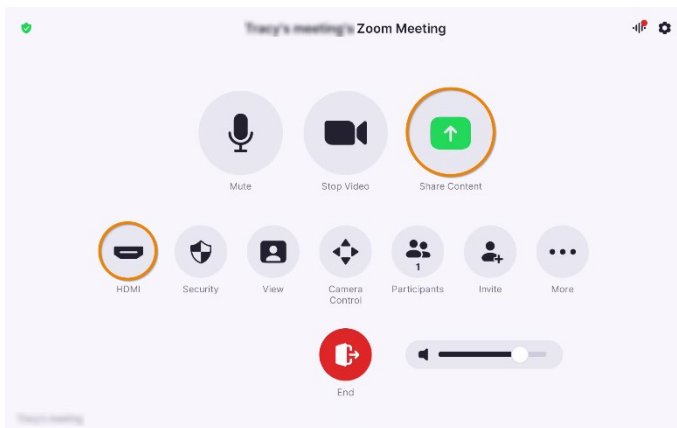

Use Zoom App or Browser

1. On the Zoom Rooms Controller, start or join a meeting.
2. Tap **Share Content**.
The controller will display a sharing key and meeting ID.

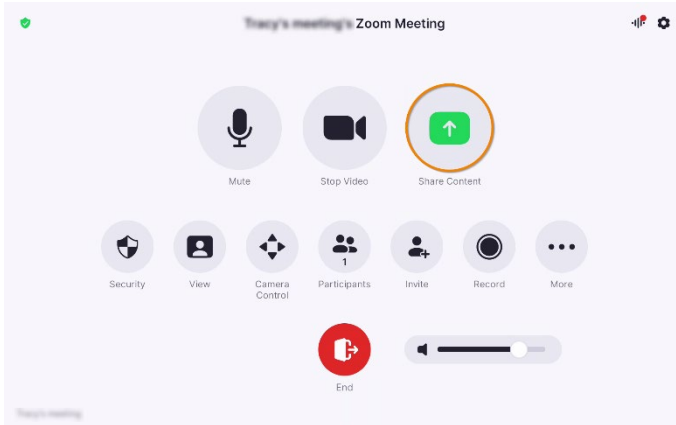

3. Sign in to the Zoom desktop app or share.zoom.us on the browser.
4. Click **Share Screen** and enter the sharing key or meeting ID. Your desktop will be shared to the Zoom Room display.

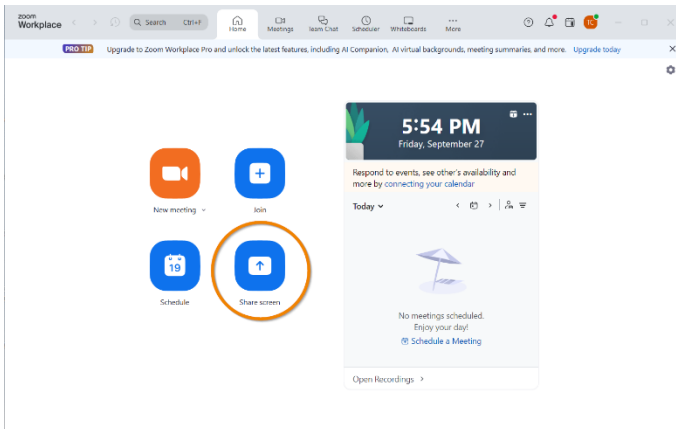

Note: For more information on Zoom Rooms, visit [Zoom Rooms and Workspaces Support](https://support.zoom.us/join).

Android Interface

Access the Android Interface

You can access the device Android interface and configure device settings from the pairing code screen.



1. Connect a monitor to the HDMI out 1 port on VB370A using the included HDMI cable. The monitor will display a pairing code.
2. Then connect a mouse to the USB port on VB370A.
3. Click **Settings** to open the Settings window.
4. Click **System Settings**.

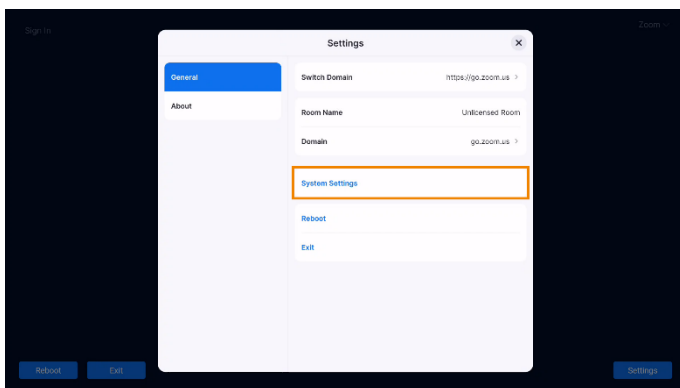

Setting Page

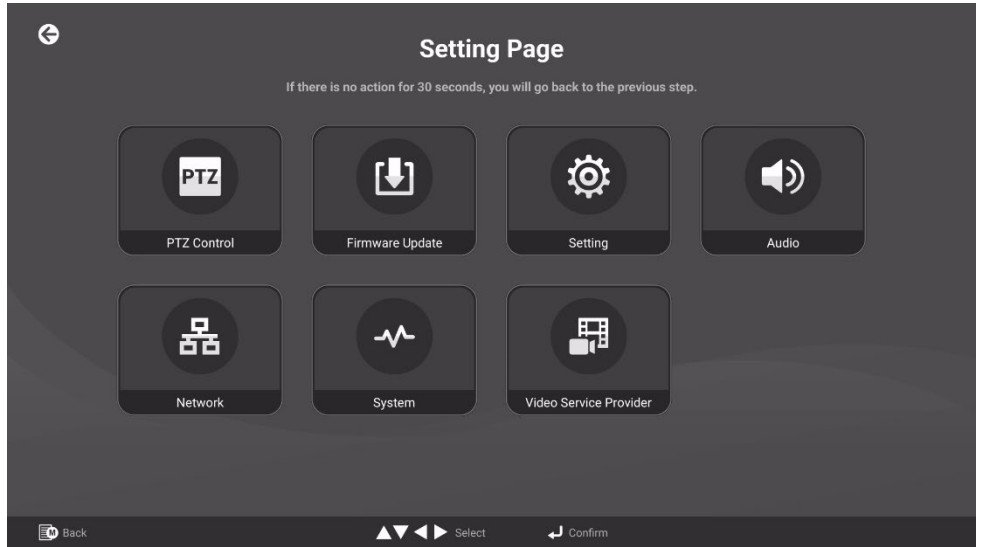

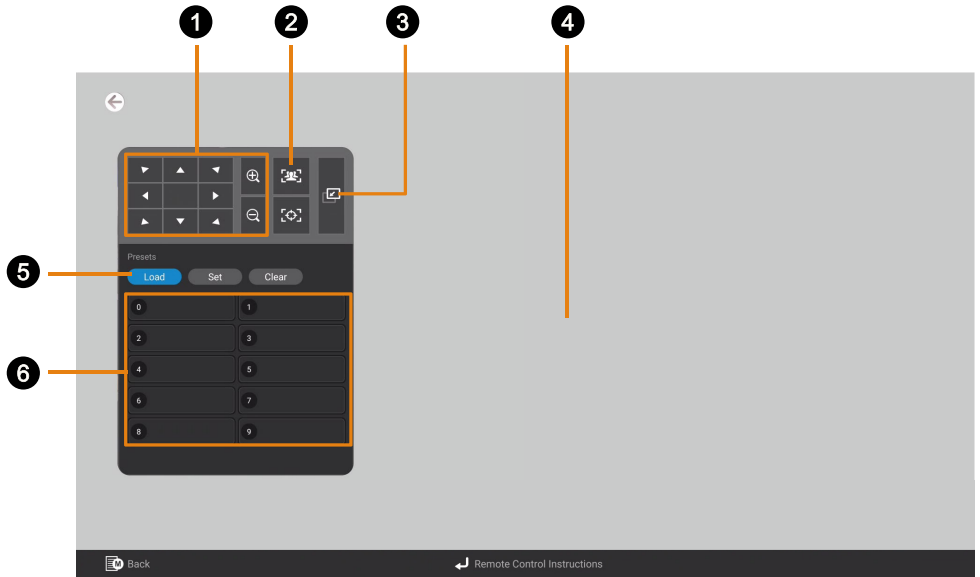

You can navigate the Setting Page using the included remote control or a mouse.

PTZ Control



1. PTZ Control

2.  SmartFrame: Click to frame entire group on screen and remove excess space.
-  One-Touch Focus: Click to autofocus once.

3. Minimize Control Panel

4. Live View

5. Preset Function

6. Preset Number

Save, Load and Clear a Preset

To save a preset:

1. Use the pan, tilt and zoom controls to position your device.
2. Select **Set**, then a preset number to save that position.
3. Select **Yes** when prompted.

To load a preset:

Select **Load**, then a preset number to load that position.

To clear a preset:

Select **Clear**, then a preset number to clear that position.

Firmware Update

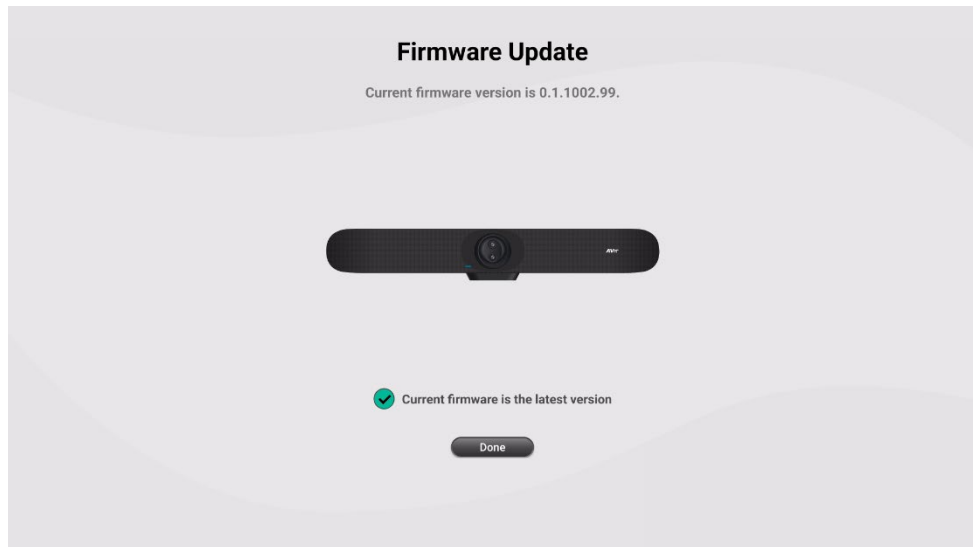

Check for and install the latest firmware update.

Setting

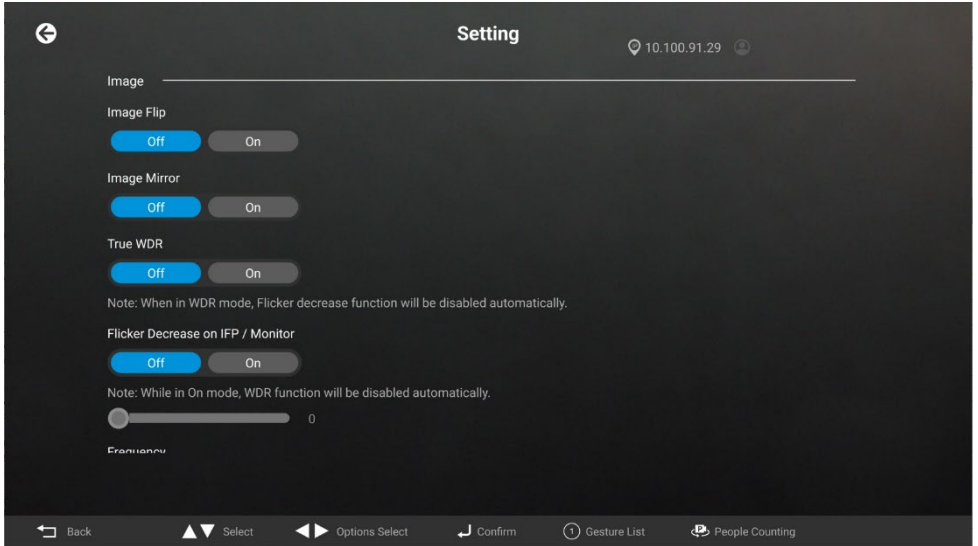

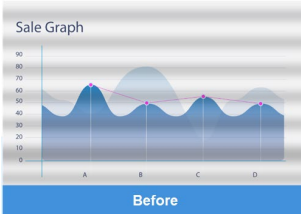
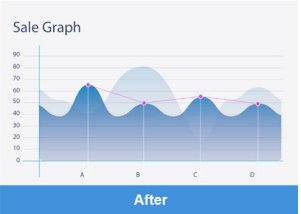
Item	Description
Image Flip	Flip the image vertically.
Image Mirror	Flip the image horizontally.
True WDR	Turn wide dynamic range (WDR) on or off.
Flicker Decrease on IFP / Monitor	Turn Flicker Decrease on IFP / Monitor on or off. <div style="display: flex; justify-content: space-around; margin-top: 10px;">   </div>
Frequency	Select a frequency.
White Balance	Select a white balance setting: <ul style="list-style-type: none"> • Manual: Adjust the white balance manually by dragging the slider. • Auto: Adjust the white balance automatically.
Noise Reduction	Adjust noise reduction level.
Brightness	Adjust brightness level.
Sharpness	Adjust sharpness level.
Saturation	Adjust saturation level.

Low Light Compensation	Turn Low Light Compensation on or off.
Allow Remote Access	Allow access to the device web interface.
Enlarge Total Zoom Up to 18x	Turn the function on or off.

Audio

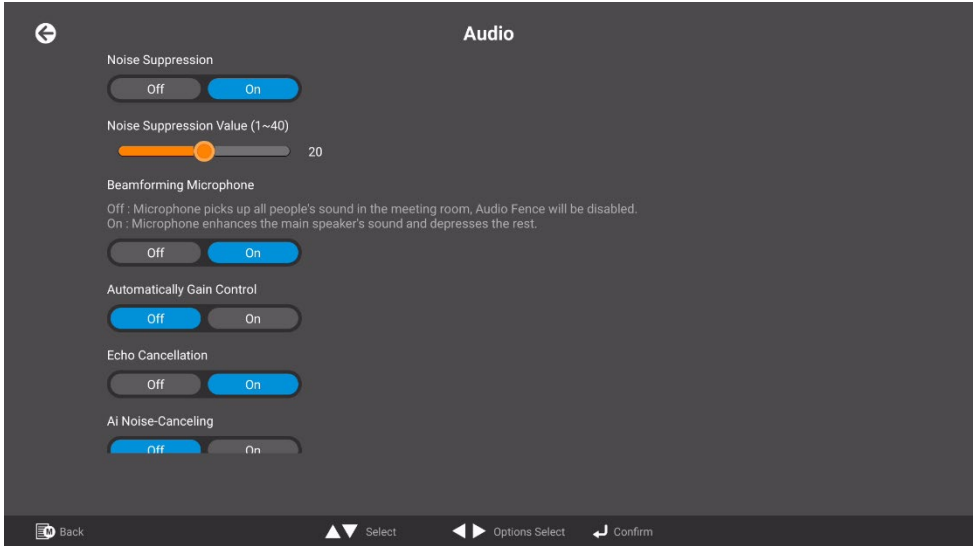

Item	Description
Noise Suppression / Value	Turn the function on to reduce ambient noise. Drag the slider to adjust the suppression value.
Beamforming Microphone	<ul style="list-style-type: none"> Off: The microphone picks up all the presenters' voices in the meeting room, and Audio Fence will be disabled. On: The microphone enhances the main presenter's voice and depresses the rest.
Automatically Gain Control	Improve and adjust the received human voices to a similar volume for the remote end.
Echo Cancellation	Reduce re-appearing sounds during online calls.
AI Noise-Canceling	Turn on the function to eliminate the background noise.
Reduce Reverberation	Turn on the function to reduce the echo in open or empty space.
Phone In Jack	<ul style="list-style-type: none"> Phone In: Connect your mobile phone to the Phone In port and use the VB370A as an external speakerphone in mobile-based video conferencing. 3.5mm External Microphone Only: Connect to an external microphone as the only audio transmitter. 3.5mm External Microphone Mix In: Connect to an external microphone for joint audio transmission with VB370A. Line Out: Connect to HA system for audio output. You

may need to purchase an audio-out adapter from AVer (TRS female to TRRS male).

Note: Avoid connecting to an external speaker when using Line Out. The speaker sound will have impact on built-in speaker and microphone performance.

Network

The screenshot shows a network configuration interface for a device labeled 'RJ45'. At the top, there is a back arrow and the title 'Network'. Below the device name, there are two radio buttons: 'Static IP' and 'DHCP'. The 'DHCP' button is selected and highlighted in blue. Underneath, there are four input fields for network settings: 'IP Address' (10.100.90.41), 'Gateway' (10.100.90.254), 'Netmask' (255.255.255.0), and 'DNS' (10.100.1.6). At the bottom of the screen, there is a navigation bar with icons for 'Back', 'Select', 'Options Select', and 'Confirm'.

Item	Description
RJ45	Set up Static IP or DHCP. <ul style="list-style-type: none">• Static IP: Enter your network settings to set up a static IP connection and click Confirm.

System

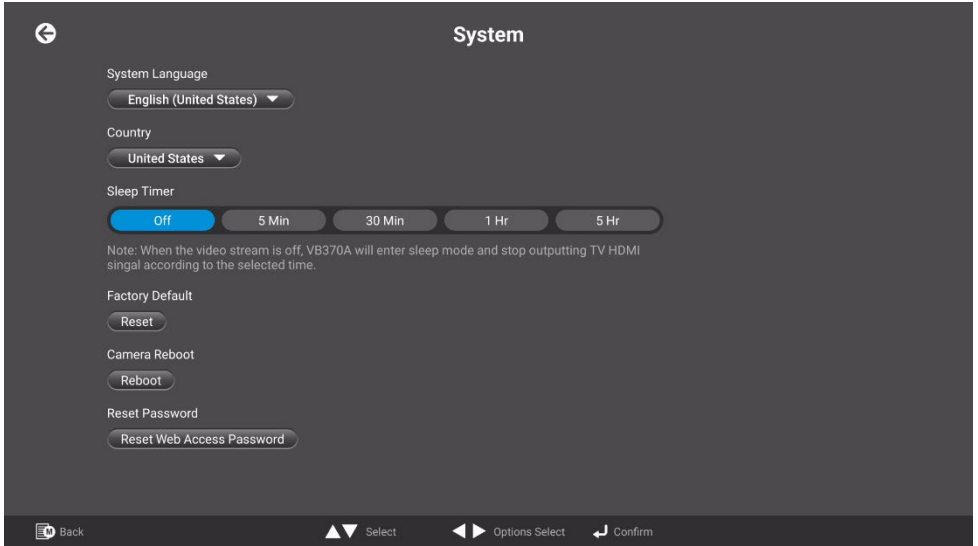

Item	Description
System Language	Select the Android interface language.
Country	Select a country or region.
Sleep Timer	Set a duration before standby mode.
Factory Default	Reset your camera to factory default settings. You can choose to keep the IP address by selecting the checkmark.
Camera Reboot	Reboot the camera.
Reset Password	Reset the web interface password. <ul style="list-style-type: none"> The default web interface password is aver4321.
Device Password	Reset or set a new device password. <ul style="list-style-type: none"> The default device password is aver4321.
Troubleshooting	N/A
Test Speakerphone	Record a 10-second message to test the microphone.
Date Format	Select a date format.
Time Format	Select a time format.
Time Correction Mode	Select a time correction mode. <ul style="list-style-type: none"> Auto: Enter your Network Time Protocol (NTP) server URL to synchronize the clock. The default NTP server is located in the US. Manual: Click the pencil icon to set up the clock.
Information	Displays your camera information such as IP address and more.

Video Service Provider Selection

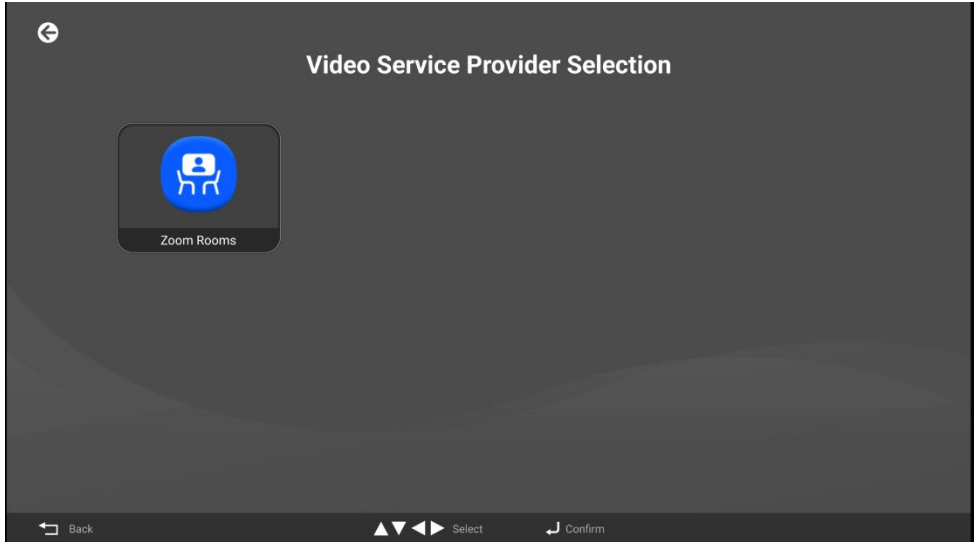

Item	Description
Zoom Rooms	Go back to the Zoom Rooms interface.

Web Interface

Access the Web Interface

You can access the camera web interface and look up IP address using AVer IP Finder.

Note:

- The camera default network is DHCP.
- The camera default password is **aver4321**.

AVer IP Finder

AVer IP finder for USB-CAM v1.0.1002.3

Network Device: Realtek PCIe GbE Family Controller [Search]

Login: Password []

Network Setting | Search Result

Select All

No.	Status	Progress	Model Name	Device Name	FW version	IPv4 Address	MAC Address	IPv6 Address
<input type="checkbox"/> 1	Working		CAM550	CAM550	0.0.8004.71	10.100.90.75:80	00:18:1a:60:4...	[]:80
<input type="checkbox"/> 2	Working		CAM570	CAM570	0.0.8102.36	10.100.90.79:80	36:69:88:11:1...	[]:80
<input type="checkbox"/> 3	Working		FONE700	FONE700	0.0.8300.81	10.100.90.172:80	00:18:1a:60:3...	[]:80
<input type="checkbox"/> 4	Working		ProAV CAM-P1	ProAV CAM-P1	0.0.9900.09	10.100.90.63:80	00:18:1a:0c:b...	[]:80
<input type="checkbox"/> 5	Working		VB342 Pro	VB342 Pro	0.0.7804.06	10.100.90.68:80	00:18:1a:0c:b...	[]:80

Settings: DHCP Static IP

*Auto search will start after settings changed!
 Don't start auto search this time!

Start IP Address: [.] [.] [.]
End IP Address: [.] [.] [.]
Subnet Mask: [.] [.] [.]
Gateway: [.] [.] [.]
Primary DNS: [.] [.] [.]

Apply

To access the web interface:

1. Download and install AVer IP Finder to your computer from AVer Download Center.
https://www.aver.com/download_center
2. Open AVer IP Finder. Click Search to see available devices on the same local area network (LAN).

Note:

- Make sure your camera has internet.
 - IP Cam Finder and camera must be on the same LAN.
3. Double click on your camera's IP address in the **IPv4 Address** column to open the web interface on your browser.

When you log in for the first time:

Enter the default password **aver4321**. You will be prompted to set up a new account name and password.

- Name: Use 8 10 characters.
- Password: Use 8 10 characters and a combination of uppercase letters, lowercase letters, numbers, and symbols ((* ! % + = , _ ^ / @ . ~ # \$)). The password cannot be the same as the username.

To change your network to DHCP or static IP:

1. Select the checkbox of your camera.
2. Enter the default password **aver4321** or changed password in the **Login** field..
3. Select **DHCP** or **Static IP**, then enter your network settings if applicable in the **Settings** section.
4. Click **Apply**.

PTZ Control

Overview of PTZ Control

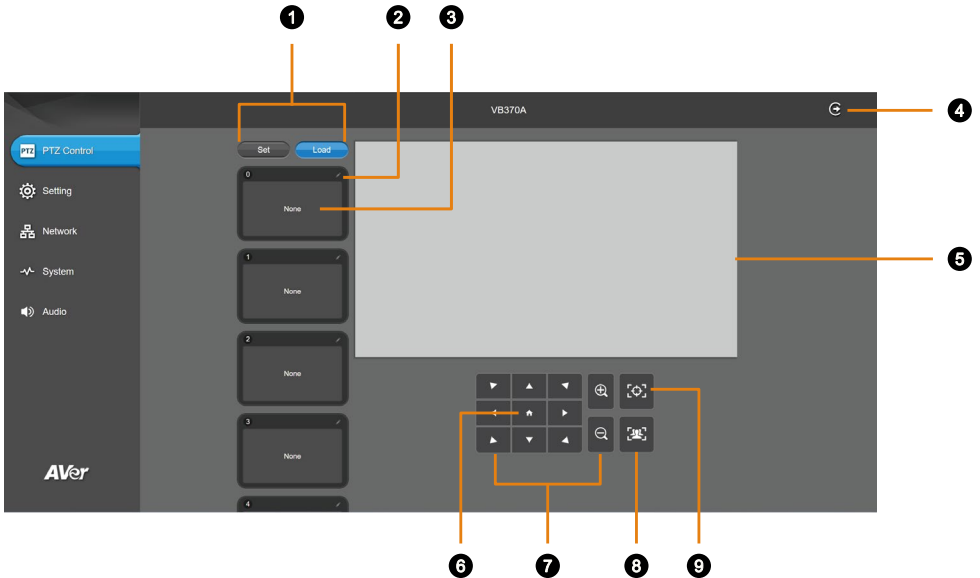

1. Preset Function

2. Name

Click the pencil icon to name a preset.

3. Preset Thumbnail

There are 10 available presets 0-9 by default.

4. Log Out

Log out of your account and close the web interface.

5. Live View

6. Pan-Tilt Reset

Reset the pan-tilt position to the center.

7. PTZ Control

8. SmartFrame

Click the **SmartFrame** icon  to frame entire group on screen and remove excess space.

9. One-Touch Focus

Click to autofocus once.

Save and Load a Preset

To save a preset:

4. Use the pan, tilt and zoom controls to position your device.
5. Select **Set**, then a preset number to save that position.
6. Select **Yes** when prompted.



To load a preset:

Select **Load**, then a preset number to load that position.

Setting

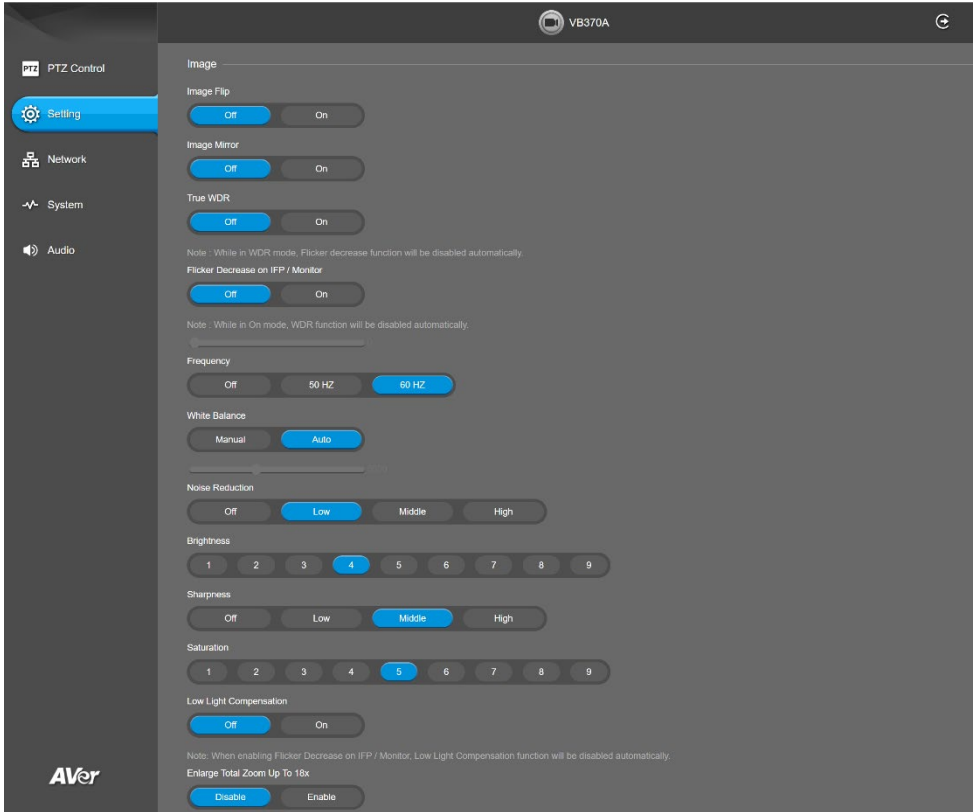

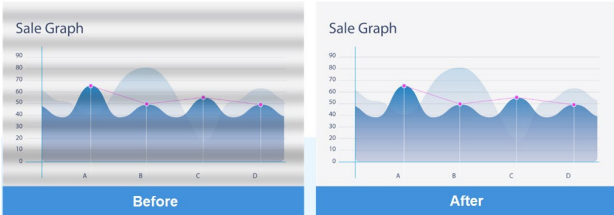
Item	Description
Image Flip	Flip the image vertically.
Image Mirror	Flip the image horizontally.
True WDR	Turn wide dynamic range (WDR) on or off.
Flicker Decrease on IFP / Monitor	Turn Flicker Decrease on IFP / Monitor on or off. 
Frequency	Select a frequency.
White Balance	Select a white balance setting:

	<ul style="list-style-type: none"> • Manual: Adjust the white balance manually by dragging the slider. • Auto: Adjust the white balance automatically.
Noise Reduction	Adjust noise reduction level.
Brightness	Adjust brightness level.
Sharpness	Adjust sharpness level.
Saturation	Adjust saturation level.
Low Light Compensation	Turn Low Light Compensation on or off.
Enlarge Total Zoom Up to 18x	Turn the function on or off.

Overview of the Floating Live View

- The floating live view opens automatically on .Setting, Network, System, and Audio tabs.
- To open the floating live view again after closing, click on the camera icon on top of Setting, Network, System, and Audio tabs.

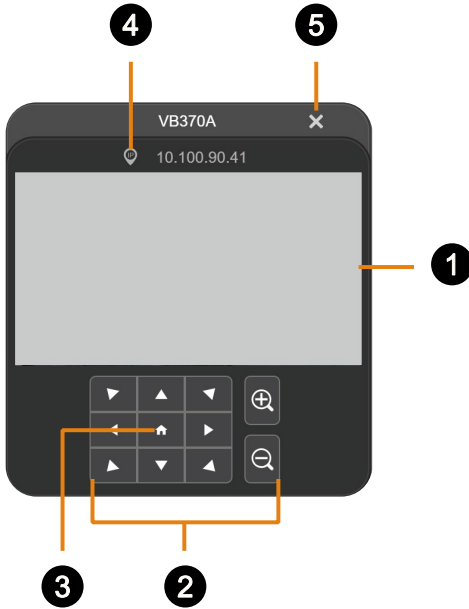

1. Live View

2. PTZ Control

3. Pan-Tilt Reset

Reset the pan-tilt position to the center.

4. IP Address

5. Close

Click the **X** icon  to close the floating live view and stop transmitting video.

Network

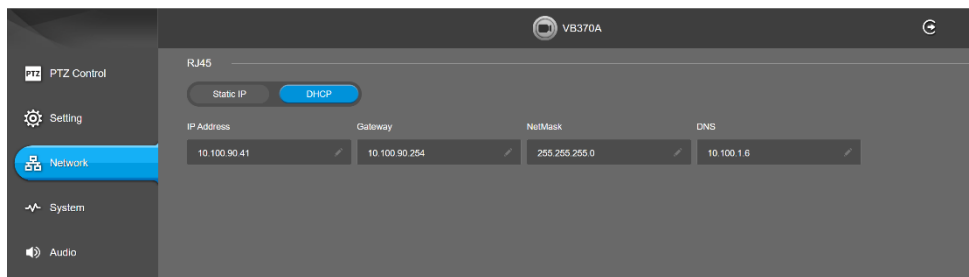

Item	Description
RJ45	Set up Static IP or DHCP. <ul style="list-style-type: none">• Static IP: Enter your network settings to set up a static IP connection and click Confirm.

System

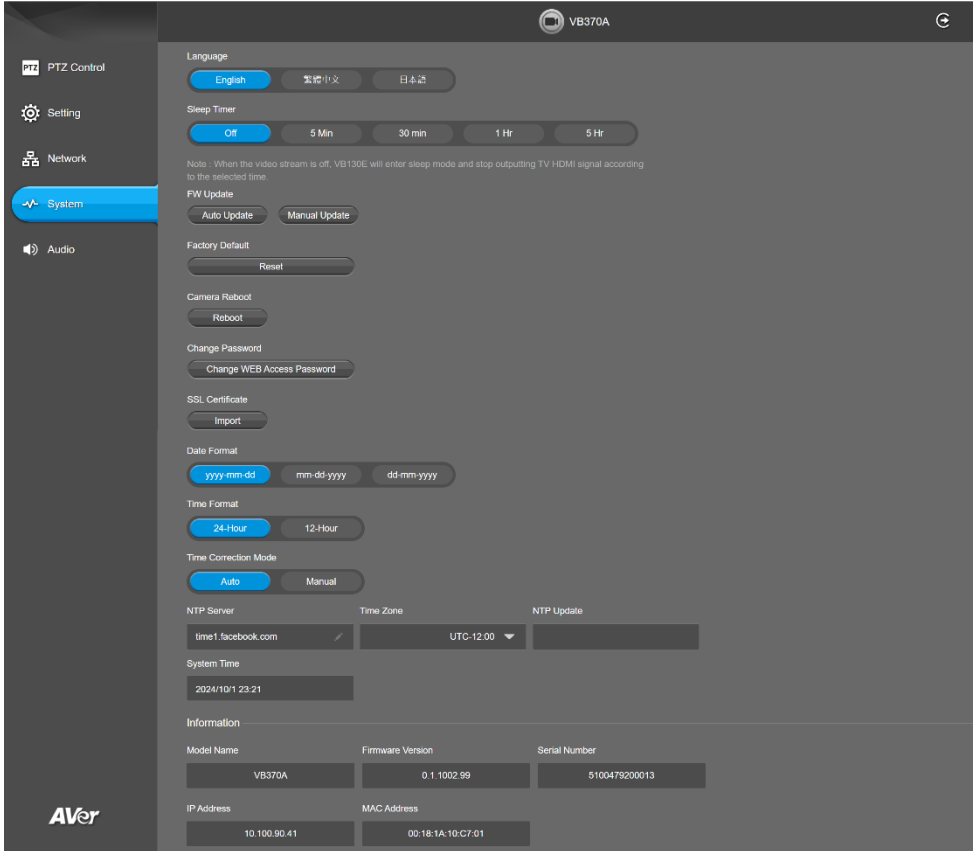

Item	Description
Language	Select a language for the web interface.
Sleep Timer	Set a duration before standby mode.
FW Update	Update your camera firmware. <ul style="list-style-type: none"> Auto Update: Check and update online. Manual Update: Update the downloaded firmware file. Note: The camera will reboot and the connection will be lost. Please wait a few minutes and keep the power cable connected. Unplugging the cable during this process may damage the device.
Factory Default	Reset your camera to factory default settings. You can choose to keep the IP address by selecting the checkmark.
Camera Reboot	Reboot the camera.

Change Password	<p>Change the web interface password.</p> <ul style="list-style-type: none"> • Use 8-10 characters and a combination of uppercase letters, lowercase letters, numbers, and symbols (* ! % + = , - _ ^ / @ . ~ # \$). The password cannot be the same as the username. • If you forgot your password, access the Android interface to reset the web interface password to the default aver4321.
SSL Certificate	Upload an SSL certificate.
Date Format	Select a date format.
Time Format	Select a time format.
Time Correction Mode	<p>Select a time correction mode.</p> <ul style="list-style-type: none"> • Auto: Enter your Network Time Protocol (NTP) server URL to synchronize the clock. The default NTP server is located in the US. • Manual: Click the pencil icon to set up the clock.
Information	Displays your camera information such as IP address and more.

Audio

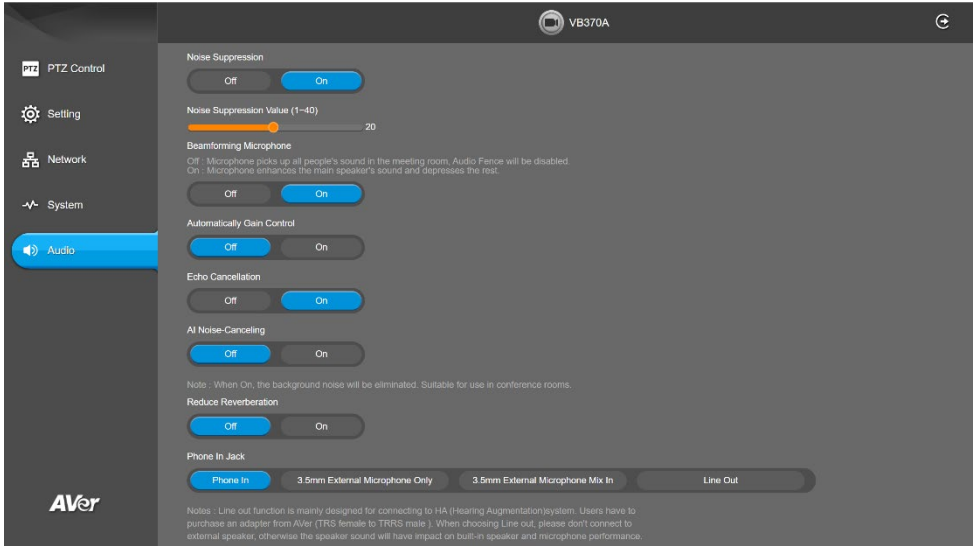

Item	Description
Noise Suppression / Value	Turn the function on to reduce ambient noise. Drag the slider to adjust the suppression value.
Beamforming Microphone	<ul style="list-style-type: none"> Off: The microphone picks up all the presenters' voices in the meeting room, and Audio Fence will be disabled. On: The microphone enhances the main presenter's voice and depresses the rest.
Automatically Gain Control	Improve and adjust the received human voices to a similar volume for the remote end.
Echo Cancellation	Reduce re-appearing sounds during online calls.
AI Noise-Cancelling	Turn on the function to eliminate the background noise.
Reduce Reverberation	Turn on the function to reduce the echo in open or empty space.
Phone In Jack	<ul style="list-style-type: none"> Phone In: Connect your mobile phone to the Phone In port and use the VB370A as an external speakerphone in mobile-based video conferencing. 3.5mm External Microphone Only: Connect to an external microphone as the only audio transmitter. 3.5mm External Microphone Mix In: Connect to an external microphone for joint audio transmission with VB370A. Line Out: Connect to HA system for audio output. You

may need to purchase an audio-out adapter from AVer (TRS female to TRRS male).

Note: Avoid connecting to an external speaker when using Line Out. The speaker sound will have impact on built-in speaker and microphone performance.