

# CAM130

# Content Camera

## User Manual



## Federal Communications Commission Statement

NOTE: This equipment has been tested and found to comply with the limits for a Class A digital device, pursuant to part 15 of the FCC Rules. These limits are designed to provide reasonable protection against harmful interference when the equipment is operated in a commercial environment. This equipment generates, uses, and can radiate radiofrequency energy and, if not installed and used in accordance with the instruction manual, may cause harmful interference to radio communications. Operation of this equipment in a residential area is likely to cause harmful interference in which case the user will be required to correct the interference at his own expense.

FCC Caution: Any changes or modifications not expressly approved by the party responsible for compliance could void the user's authority to operate this equipment.

This device complies with part 15 of the FCC Rules.

Operation is subject to the following two conditions:

- (1) This device may not cause harmful interference, and
- (2) this device must accept any interference received, including interference that may cause undesired operation.

### Warning:

This is a class A product. In a domestic environment this product may cause radio interference in which case the user may be required to take adequate measures.

This Class A digital apparatus complies with Canadian ICES-003. Cet appareil numérique de la classe A est conforme à la norme NMB-003 du Canada.

この装置は、クラス A 機器です。この装置を住宅環境で使用すると電波妨害を引き起こすことがあります。この場合には使用者が適切な対策を講ずるよう要求されることがあります。 VCCI-A

사 용 자 안 내 문
이 기기는 업무용 환경에서 사용할 목적으로 적합성평가를 받은 기기로서 가정용 환경에서 사용하는 경우 전자파간섭의 우려가 있습니다.
※ 사용자 안내문은 "업무용 방송통신기자재"에만 적용됩니다.

기종별	사용자안내문
A 급 기기 (업무용 방송통신기자재)	이 기기는 업무용(A 급) 전자파적합기기로서 판매자 또는 사용자는 이 점을 주의하시기 바라며, 가정외의 지역에서 사용하는 것을 목적으로 합니다.

## **DISCLAIMER**

No warranty or representation, either expressed or implied, is made with respect to the contents of this documentation, its quality, performance, merchantability, or fitness for a particular purpose. Information presented in this documentation has been carefully checked for reliability; however, no responsibility is assumed for inaccuracies. The information contained in this documentation is subject to change without notice.

In no event will AVer Information Inc. be liable for direct, indirect, special, incidental, or consequential damages arising out of the use or inability to use this product or documentation, even if advised of the possibility of such damages.

## **TRADEMARKS**

“AVer” is a trademark owned by AVer Information Inc. Other trademarks used herein for description purpose only belong to each of their companies.

## **COPYRIGHT**

©2021 AVer Information Inc. All rights reserved.

All rights of this object belong to AVer Information Inc. Reproduced or transmitted in any form or by any means without the prior written permission of AVer Information Inc. is prohibited. All information or specifications are subject to change without prior notice.

## **NOTICE**

SPECIFICATIONS ARE SUBJECT TO CHANGE WITHOUT PRIOR NOTICE. THE INFORMATION CONTAINED HEREIN IS TO BE CONSIDERED FOR REFERENCE ONLY.

## WARNING

- To reduce risk of fire or electric shock, do not expose this appliance to rain or moisture. Warranty will be void if any unauthorized modifications are done to the product.
- Do not drop the camera or subject it to physical shock.
- Use correct power supply voltage to avoid damaging camera.
- Do not place the camera where the cord can be stepped on as this may result in fraying or damage to the lead or the plug.
- Hold the bottom of the camera with both hands to move the camera. Do not grab the lens or lens holder to move the camera.

### Remote Control Battery Safety Information

- Store batteries in a cool and dry place.
- Do not throw away used batteries in the trash. Properly dispose of used batteries through specially approved disposal methods.
- Remove the batteries if they are not in use for long periods of time. Battery leakage and corrosion can damage the remote control. Dispose of batteries safely and through approved disposal methods.
- Do not use old batteries with new batteries.
- Do not mix and use different types of batteries: alkaline, standard (carbon-zinc) or rechargeable (nickel-cadmium).
- Do not dispose of batteries in a fire.
- Do not attempt to short-circuit the battery terminals.

### CAUTION

- Risk of explosion if battery is replaced by an incorrect type.
- Dispose of used batteries in a safe and proper manner.

### 遥控器电池安全信息

- 请将电池存放在凉爽与干燥的位置。
- 不要将电量用尽的电池弃置在家庭废弃物中。请将电池弃置在特定回收处，或送回原购买的商店。
- 如果长时间不使用电池，请将其取出。电池漏液与腐虫可能会损坏遥控器，请以安全方式弃置电池。
- 不可混用新旧电池。
- 不可混用不同类型的电池：碱性、标准（碳锌）或可充电（镍镉）电池。
- 不可将电池弃置于火源中。
- 请勿尝试让电池端子短路。

## More Help

For FAQs, technical support, software and user manual download, please visit:

### Headquarters

Download Center: <https://www.aver.com/download-center>  
Technical Support: <https://www.aver.com/technical-support>

### USA Branch office

Download Center: <https://www.averusa.com/business/support/>  
Technical Support: <https://averusa.force.com/support/s/contactsupport>

### Europe Branch office

Download Center: <https://www.avereurope.com/download-center>  
Technical Support: <https://www.avereurope.com/technical-support>

## Contact Information

### Headquarters

AVer Information Inc.

<https://www.aver.com>

8F, No.157, Da-An Rd., Tucheng Dist., New Taipei City 23673, Taiwan

Tel: +886 (2) 2269 8535

### USA Branch office

AVer Information Inc., Americas

<https://www.averusa.com>

668 Mission Ct., Fremont, CA 94539, USA

Tel: +1 (408) 263 3828

Toll-free: +1 (877) 528 7824

Technical support: [support.usa@aver.com](mailto:support.usa@aver.com)

### Europe Branch office

AVer Information Europe B.V.

<https://www.avereurope.com>

Westblaak 134, 3012 KM, Rotterdam, The Netherlands

Tel: +31 (0) 10 7600 550

Technical support: [eu.rma@aver.com](mailto:eu.rma@aver.com)

### Japan Branch Office

アバー・インフォメーション株式会社

<https://jp.aver.com>

〒160-0023 日本東京都新宿区西新宿 3-2-26 立花新宿ビル 7 階

Tel: +81 (0) 3 5989 0290

テクニカル・サポート: [VCIInfo.JP@aver.com](mailto:VCIInfo.JP@aver.com)

### Vietnam Branch Office

Công ty TNHH AVer Information (Việt Nam)

Tầng 5, 596 Nguyễn Đình Chiểu, P.3, Quận 3, Thành phố Hồ Chí Minh 700000, Việt Nam

Tel: +84 (0)28 22 539 211

# Contents







Content Camera Bundle Kit Package .....	1
Optional Accessories .....	1
Product Introduction .....	2
Overview .....	2
LED Indicator .....	2
How to Control Fill Light .....	3
Control Fill Light via Device Buttons .....	3
Control Fill Light via Remote Control .....	3
Installation .....	7
How to Install Whiteboard Mount and CAM130 Content Camera .....	8
How to Set CAM130 Content Camera as Content Camera in Teams Rooms .....	12
How to Set CAM130 Content Camera as Content Camera in Desktop Teams .....	14
Operating the Camera .....	16
Make a Video Call in MTR .....	16
PTZApp 2 .....	17
Install PTZApp 2 .....	17

Use PTZApp 2 with USB Devices .....	17
PTZ Control .....	22
Setting > Camera Settings .....	24
Tracking Mode .....	24
Framing Speed .....	26
Home Position .....	26
On Screen Menu .....	26
Save Preset .....	26
Fill Light .....	27
Setting > Image Settings .....	28
Field of View .....	28
Image Flip .....	28
Image Mirror .....	28
True WDR .....	29
Flicker Decrease on IFP / Monitor .....	29
Frequency .....	29
White Balance .....	30
Noise Reduction .....	30
Brightness .....	30

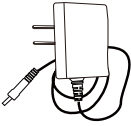
Sharpness.....	30
Saturation .....	30
Low resolution under 720p .....	31
Resolution Mode.....	31
Enlarge Total Zoom Up To 5x .....	31
System .....	32
Firmware Update .....	32
Factor Default .....	32
Trouble Shooting .....	33
Information.....	33
Audio .....	34
Microphone.....	34
Keystone Correction Configuration .....	35
EZLive .....	38
Use AVer EZLive .....	38

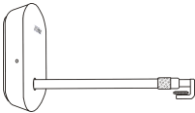
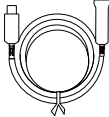

# Content Camera Bundle Kit Package

<b>CAM130 Content Camera Unit &amp; Lens Cover</b>	<b>Power Adapter and Plug*</b>	<b>Tripod Screw</b>	<b>USB 3.1 Type-C to Type-A Cable (1.8m)</b>
			
<b>QR Code Card</b>	<b>Whiteboard Mount</b>	<b>USB 3.1 Extender 10m**</b>	<b>Remote Control</b>
			

- \* The power plug will vary depending on the standard power outlet of the country where it is sold.
- \* The power adapter will be required to support the fill-light function only when connecting CAM130 Content Camera to PC USB 2.0 port.
- \*\* This extender only supports USB3.0 port of PC. Make sure your PC or MTR has USB3.0 port. Otherwise, please purchase USB2.0 extender from the market, such as the Aten UE2120. Please check our compatibility list before purchasing.

<https://www.aver.com/Knowledge-Learns/conferencing-collaboration/compatibility-list>

## Optional Accessories

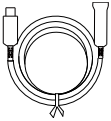
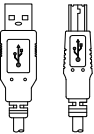
<b>USB 3.1 Extender 10m/20m/30m</b>	<b>USB 2.0 Type-C to Type-A Cable (5m)*</b>
	

# Product Introduction

## Overview

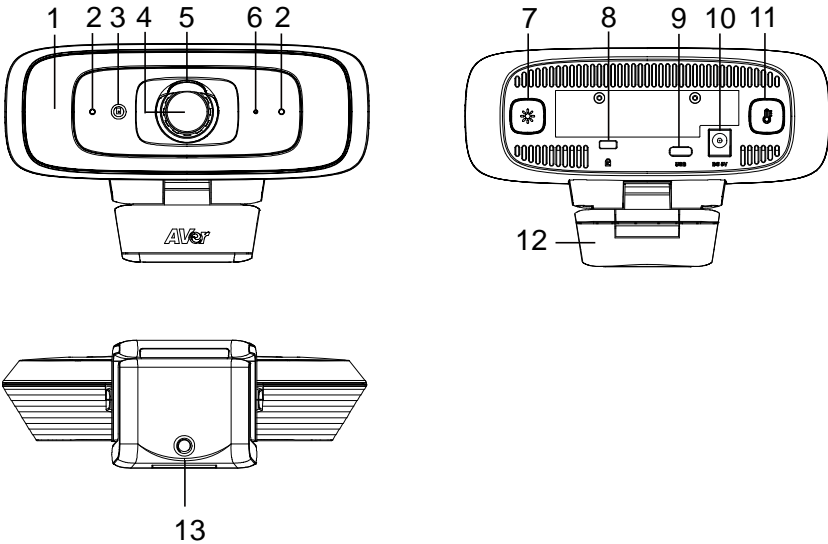

- (1) Fill Light\*
- (2) Microphones\*\*
- (3) Color Sensor
- (4) Lens
- (5) Lens Cover
- (6) LED Indicator
- (7) Light Level Button
- (8) Kensington Lock
- (9) USB 3.1 Type-C Port
- (10) DC 5V Power Jack
- (11) Color Temperature Button
- (12) Camera Clip
- (13) Tripod Screw Hole





\* The fill light function is set “Manual mode” as default. Please use PTZApp 2 to change the settings.  
\*\* The built-in microphone of CAM130 Content Camera is disabled as default. Please use PTZApp 2 to change the settings.

## LED Indicator

<b>Power on:</b> Solid red
<b>Start-up:</b> Solid red
<b>Power cable connected but USB cable unplugged:</b> Solid orange
<b>Video mute:</b> Solid white
<b>Video on:</b> Solid blue



# How to Control Fill Light

## Control Fill Light via Device Buttons

- Hold either temperature button  or light level button  for 2~3 sec. to switch on/off fill light function.
- Hold both temperature button  and light level button  together for 2~3 sec. to switch between auto/manual light adjustment. The message below will show on the image screen.

Auto Light

Manual Light

- Whether under auto or manual light adjustment mode, user can press the  button to slightly adjust color temperature or press the  button to adjust light level.



**[Note]** The light brightness level in manual mode is much higher than auto mode. There are 12 levels for adjustment.

- The camera can memorize the last setting or back to default. Please do advanced settings of the fill light function via PTZApp 2.
- The color temperature ranges from 2700k to 5700k.

### [Notes]

1. By default, fill light function is set as “Manual”. You can use PTZApp 2 to change the setting to “Auto” to automatically adjust the lighting level based on actual environment when video streaming is on. Please refer to page 30.
2. Users can do advanced lighting behavior setting under manual light adjustment mode via AVer PTZApp 2.
3. The fill light brightness level is much higher while connecting the camera to power with power adapter.
4. If you want to unplug the power adapter while USB video streaming is on, please turn off fill light first to avoid system shut down.
5. Power adapter will be required to support fill light function only when connecting CAM130 Content Camera to PC USB 2.0 port.

## Control Fill Light via Remote Control

- Long press either  or  button for 1~2 sec. to turn on/off the fill light function.

**[Note]** When fill light is on, press  or  button to increase/ decrease light level.

## ■ Remote Control (Optional)

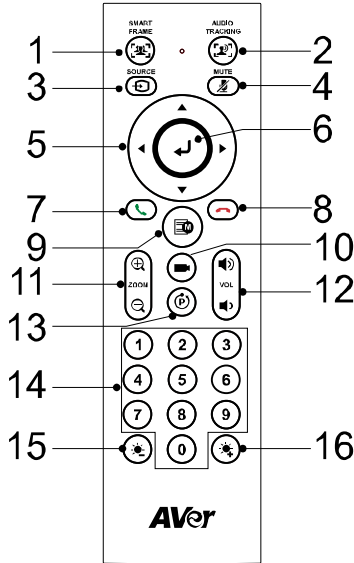

Name	Function
------	----------

### 1. SmartFrame

One-click automatic FOV adjustment to fit all participants. Press for 1~2 sec. to switch the SmartFrame function among Manual Framing/Auto Framing/Preset Framing modes. A message (as figures shown) will display on the middle bottom of the screen to indicate the mode.









While in Auto Framing mode, an icon message (as figure shown) will display on the upper left screen to indicate in SmartFrame status. The icon will appear 2~3 sec. on the screen. Once the process is done, it will disappear. Disable this function, go to PTZApp 2 On Screen Menu and then select "Off".

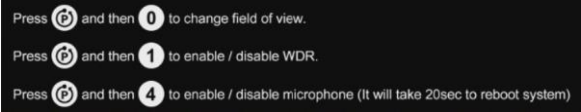

### [Notes]

- SmartFrame deploys face and body detection technology. People wearing masks and side facial profiles can still be detected. The maximum detection distance is 5 meters.

Name	Function
	<ul style="list-style-type: none"> <li>■ Camera will track people while moving. It will start to focus and zoom in once people stop moving for 1~5 seconds, depending on the framing speed you choose via PTZApp 2. The default framing speed is “Middle” speed. “High” speed is more suitable for one person tracking.</li> <li>■ Preset Framing: Set up preset points in advance (Only for Preset points 1~9. Preset 0 is for home position). Camera tracks one presenter and shoots the preset areas instead of focusing and zooming into presenter.</li> <li>■ When changing to FOV 90 degree mode, SmartFrame function will be disabled.</li> </ul>
2. Audio Tracking	Not supported.
3. Source	Not supported.
4. Mute/Unmute	Not supported.
5. Navigation Button	Press the navigation button to navigate camera view or press and hold it to adjust the camera's angle.
6. Enter	Press it to show the current AI function on screen such as Auto Framing.
7. Call/Answer	Answer a call or start a call.
8. End Call	End the call.
9. OSD Menu (HDMI Out)	Not supported.
10. Load Preset Hotkey	Press it to move to preset position as user has set in sequence.
11. Zoom In/Zoom Out	Increase/Decrease the camera zoom.
12. Volume Up/Down	Adjust volume up or down.
13. Compound Key	When press this button, the following photo will show up. Then press the corresponding number key for setting up Specified function.
	
	<ul style="list-style-type: none"> <li>■ <b>FOV:</b> Press (P) and then 0 to change field of view between 90 degree and 120 degree.</li> </ul>
	<p><b>[Note]</b> When changing to FOV 90 degree mode, SmartFrame function will be disabled.</p>
	<ul style="list-style-type: none"> <li>■ <b>WDR:</b> Press (P) and then 1 to enable/disable the WDR function.</li> </ul>

Name	Function
	<ul style="list-style-type: none"> <li>■ <b>Microphone:</b> Press  and then  to enable/disable microphone function. This setting will force system reboot. It will take 20 seconds for system reboot.</li> </ul>
14. Number Buttons/Preset Position	<ul style="list-style-type: none"> <li>■ Long press the number button to set the preset point.</li> <li>■ One-click the number button to load the preset point.</li> </ul>
15. Brightness -	<ul style="list-style-type: none"> <li>■ Long press either  or  button for 1~2 sec to turn on/off the fill light function.</li> <li>■ When fill light is off, press this button to decrease image brightness.</li> <li>■ When fill light is on, press this button to decrease light level.</li> </ul>
16. Brightness +	<ul style="list-style-type: none"> <li>■ Long press either  or  button for 1~2 sec to turn on/off the fill light function.</li> <li>■ When fill light is off, press this button to increase image brightness.</li> <li>■ When fill light is on, press this button to increase light level.</li> </ul>

# Installation

The CAM130 Content Camera can be mounted onto the wall or ceiling using the Whiteboard Mount (refer to Bundle Kit Package).

## Wall Mount Mode

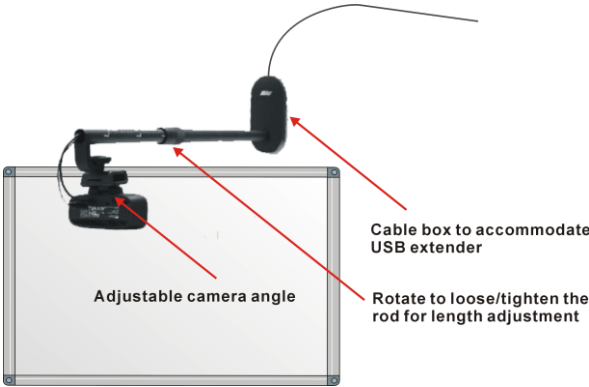

## Ceiling Mount Mode

Make sure that the camera has captured the frames of whiteboard completely.

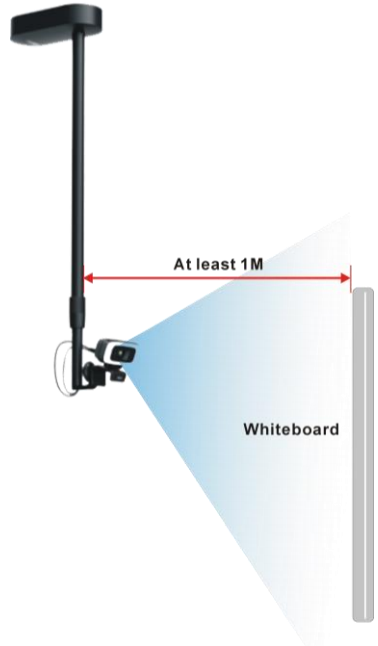

## Equipment:

1. CAM130 Content Camera.
2. USB3.1 Type-C to Type-A cable (1.8m is included in the CAM130 content camera package).
3. AVer whiteboard mount kits (Rod, Box and two M4x5mm screws).
4. AVer USB3.1 extender (10m is included in CAM130 Content Camera bundle kit. 20m and 30m are optional).
5. MTR system (support USB3.0 USB port).

## How to Install Whiteboard Mount and CAM130 Content Camera

1. Mount the bottom case of the Box to the wall 3cm above the center line of whiteboard/IFP space (or mount it to the ceiling).

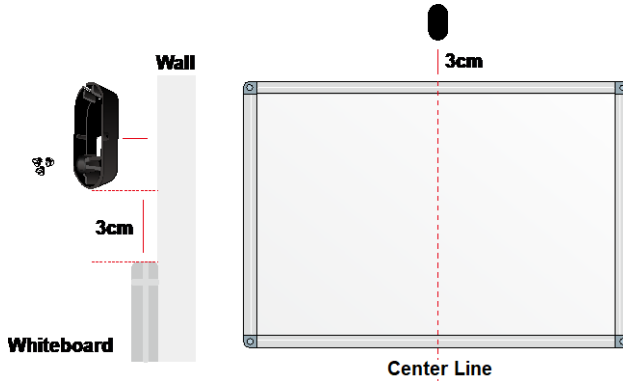

**[Note]** Please prepare three screws before mounting (not included in the package). The diameter of the three screw holes on the bottom case is  $\varnothing 6\text{mm}$ .

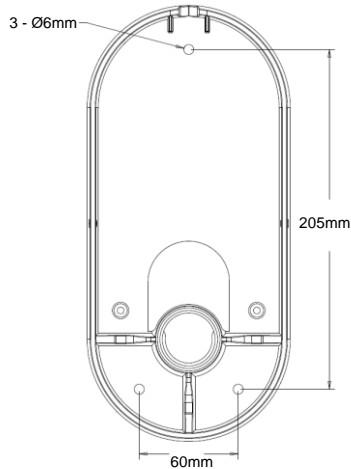

2. Insert the cable (Type A side) into the rod hole till the end of the rod. Leave 20cm of the cable for connecting to the camera.

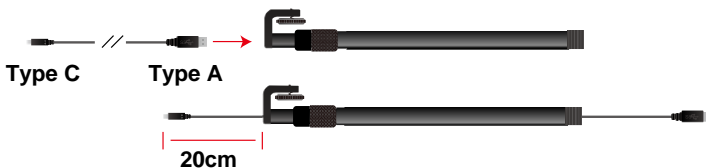



3. Align the top case with the bottom case of the Box, insert the rod into the hole of both cases, and then rotate the rod to get it tightened with the box.

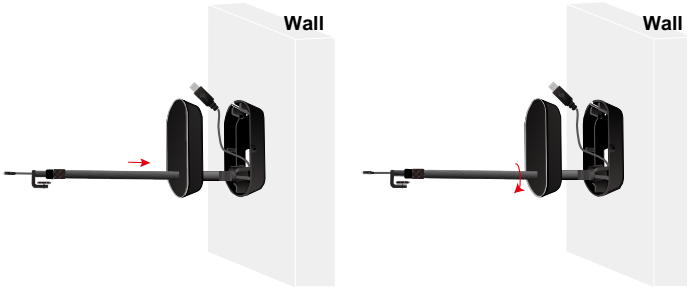

4. Connect the USB Type A side to the female connector of USB3.1 Extender Cable and house the joins inside the Box.

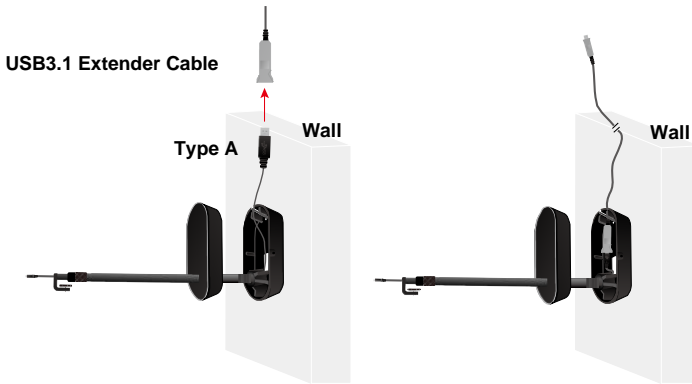

5. Secure the top case to the bottom case with the supplied two M4x5mm screws.

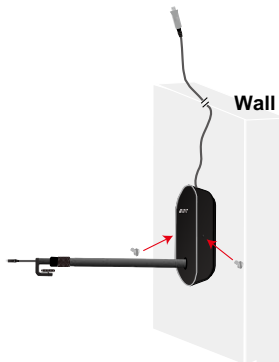

6. Install CAM130 Content Camera to another end of the rod and turn the wheel to lock it.

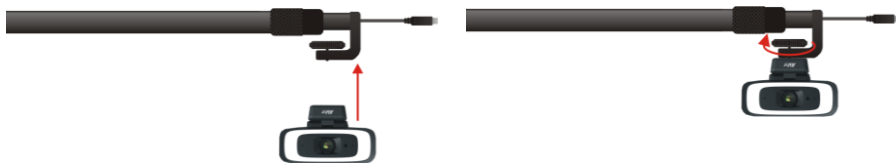

7. Connect USB Type C to the Type C port located on the back of camera.



8. Rotate the rotating ring on the rod to adjust the rod length and rotate it again in the opposite direction to lock.

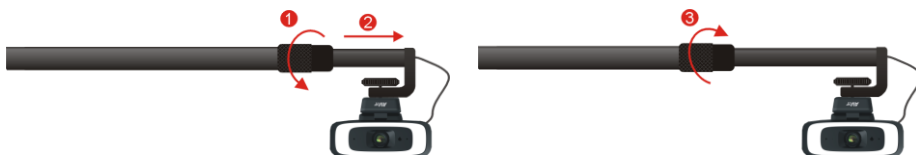

9. Connect USB3.1 extender to MTR USB3.0 port. USB extender only supports USB3.0 port. Power on MTR and set it up in teams room. Make sure there is USB3.0 port in MTR since USB extender doesn't support USB2.0 port of PC/MTR. If using USB2.0 USB extender and want to use fill-light function, please connect power adapter to camera.

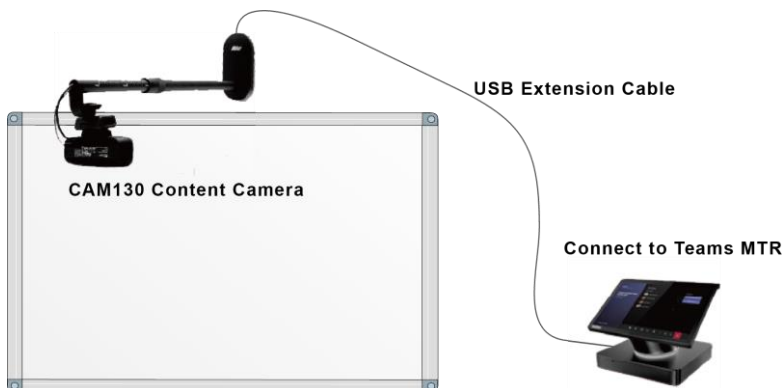

10. Connect HDMI out of MTR system to TV monitor and use preview function to see the content camera image. Adjust the camera clip to ensure the camera capture the frames of the whiteboard.

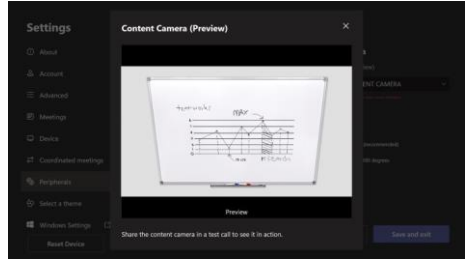
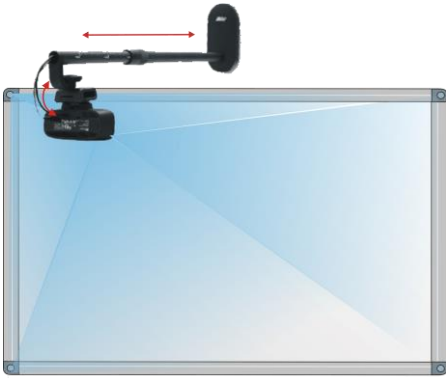

11. The rod of whiteboard mount can be adjusted in length from 80cm to 120cm as required.

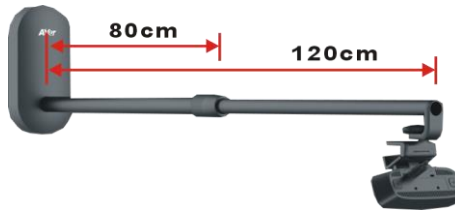

### Rod Length vs. whiteboard/IFP size

Whiteboard Size (L)	Rod Length	Mounting Method
<1.2 meters	80cm	Mount 3cm above the center of the board
1.2~1.7 meters	100cm	
1.8~2 meters	120cm	
Any Size	80~120cm	Install the mount on the ceiling and the location is in front of central top of the board. It is suggested to place the camera at least 1m away from the board to ensure complete capturing of the board frames.

## How to Set CAM130 Content Camera as Content Camera in Teams Rooms

For a fluid meeting room experience, we recommend setting up two cameras. One is the front room camera used to capture all participants (such as VB130 in huddle space or VC520Pro2 in mid to large room). The other is CAM130 Content Camera to capture whiteboard content.

To set up CAM130 Content Camera as a “Content Camera” in Teams Room:

1. Tap “More” to open the sidebar. From here, tap “Settings”.

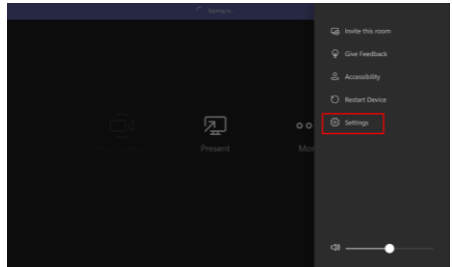
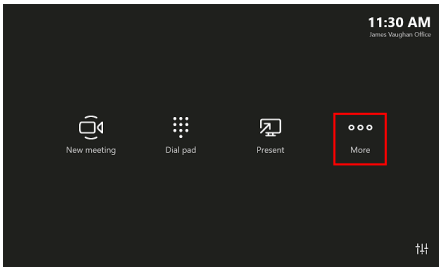

2. Select Peripherals and then CAM130 Content Camera in Content camera item. Select Rotate content camera 180 degrees and suggest to enable Content enhancements. Save and exit.

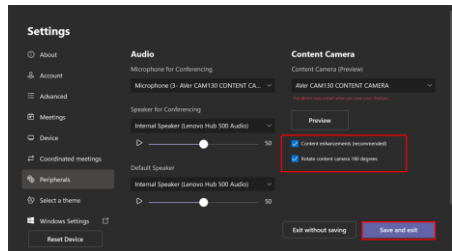
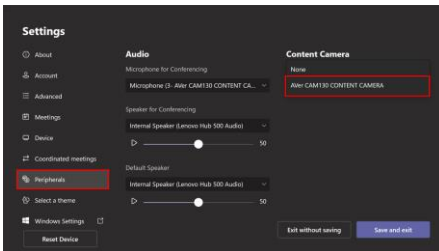

**[Notes]** If Content enhancements is selected in Microsoft® Teams, please disable AVer Keystone function to perform better keystone feature.

3. You can use preview function to check if the camera can capture the whole whiteboard area. Make sure the frame of the board is completely covered in the camera field of view.

**[Notes]** On full wall whiteboards, you can use dark-colored tape to create frames on top/bottom/left/right to defined content area.

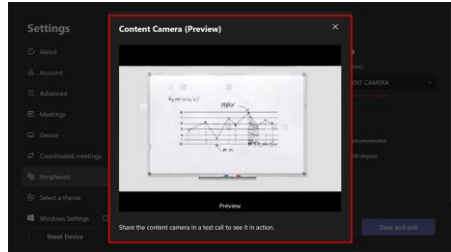
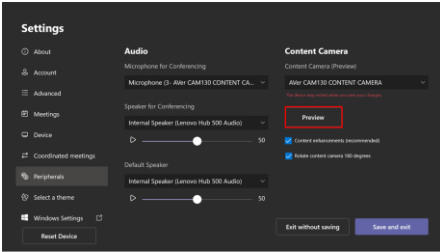

4. Select screen share function to show the view of content camera to remote site. Please connect HDMI out to monitor to see local site content camera view.

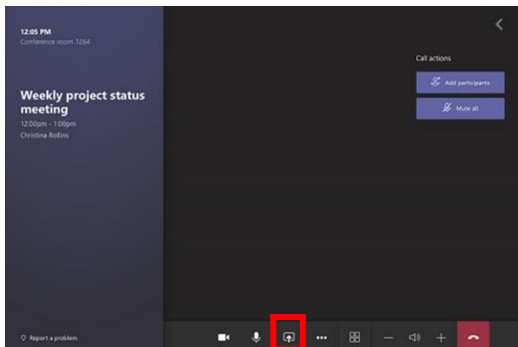

5. After setting (make sure you have enabled "Content enhancements"), the keystone correction function in teams room will take effect automatically to auto find, crop and enlarge whiteboard to full screen. Meanwhile, you will see clearer text, improved marker color visibility and readability; Captured presenter in the scene will be transparent while in front of the whiteboard



## How to Set CAM130 Content Camera as Content Camera in Desktop Teams

1. Connect CAM130 content camera to PC or laptop. Make a call and then choose it as camera source in Device settings.

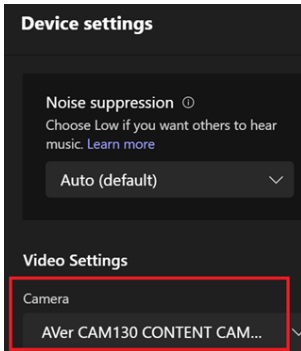

2. When the call starts, click the Share button. Access "Content from camera" and select "Document".

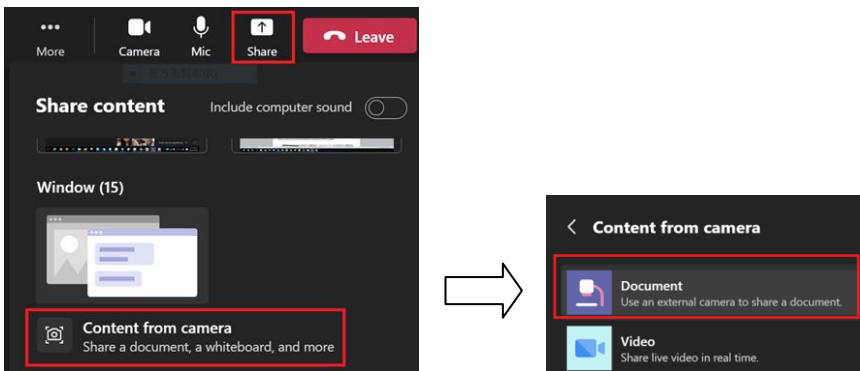

3. The on screen instruction will ask you to put the document in the view of the camera. Click "Got it".

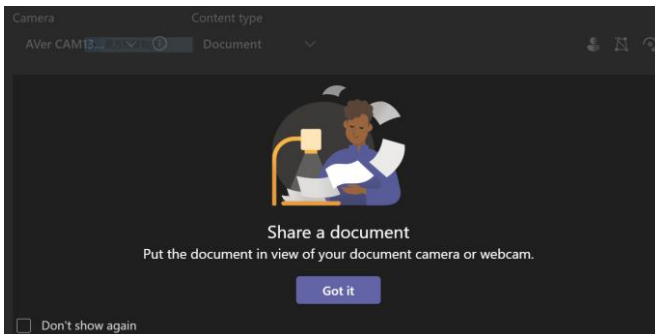

4. The auto detect starts to capture the whiteboard with four frames. When you see the green rectangle, it means the detection is successful and it will enlarge the whiteboard content into full screen. Remember to select "Whiteboard" in Content type to enable people translucent effects.

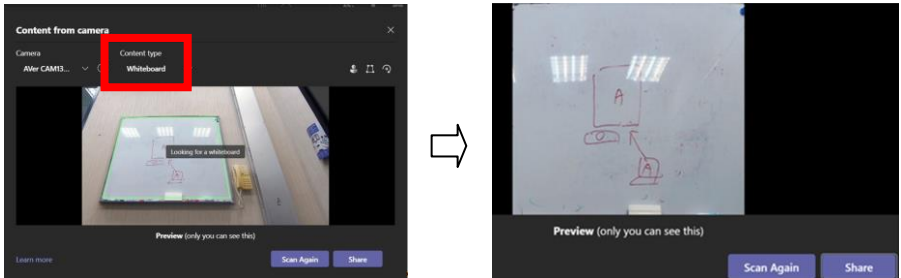

5. Click the Share button to share the whiteboard content to the teams meeting.

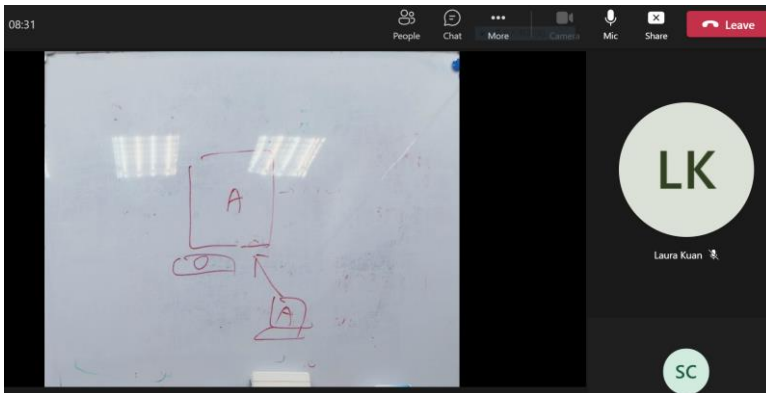

# Operating the Camera

## Make a Video Call in MTR

1. CAM130 Content Camera is a certified content camera in Teams room. However, it also can be used as a video conference camera in Teams room. If you connect only one CAM130 Content Camera in MTR and choose it as content camera, it will be occupied and can't be used as a conference camera at the same time. Make sure you prepare another Teams certified USB conference camera to capture all participants.
2. Make sure all devices (CAM130 Content Camera, Teams certified USB camera (ex:AVer VB130), laptop or PC or MTR, TV/monitor) are well connected and powered on.
3. Run your, Microsoft® Teams
4. Set the CAM130 Content Camera as the content camera. You can now make your call.

**[Note]** The CAM130 Content Camera is a plug-and-play camera. The system requires no special drivers, but we do recommend installing the PTZApp 2 for a better user experience. For information on how to install and use the PTZApp 2, refer to the PTZApp 2 section in this user manual.



# PTZApp 2

In PTZApp 2, user can configure the parameters of the camera, set up AI tracking functions and some advanced image settings, pan, tilt, and zoom the camera.

## Install PTZApp 2

Please go to <https://www.aver.com/download-center> (Headquarters & Europe) or <https://www.averusa.com/business/support/> (USA) to download the PTZApp 2. After downloading, double-click on the file and follow the on-screen instructions to complete the installation. After installing the PTZApp 2, double-click on the PTZApp 2 icon to run the application.

**[Note]** PTZApp 2 runs on web browser. It doesn't support IE browser. It is suggested to set up your default browser to Chrome.

## Use PTZApp 2 with USB Devices

1. Run your video application and make a video call.
2. During your video call, you can use the PTZApp 2 to pan, tilt and zoom the camera in/out and enable/disable the true WDR, brightness, and sharpness feature.
3. Launch PTZApp 2 () and it will open in Chrome browser automatically.

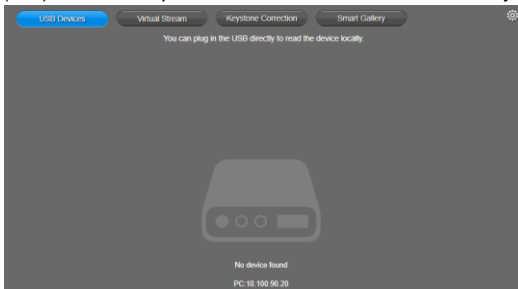

4. Choose "USB Devices" and connect the camera to PC/laptop with USB cable. When the camera is detected, the product card will show up.

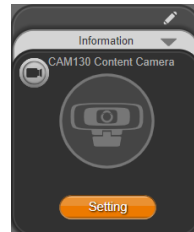
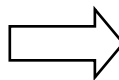

5. Click the Setting icon in the upper-right corner to change Language, Hotkey Control, and PTZApp 2 Version.

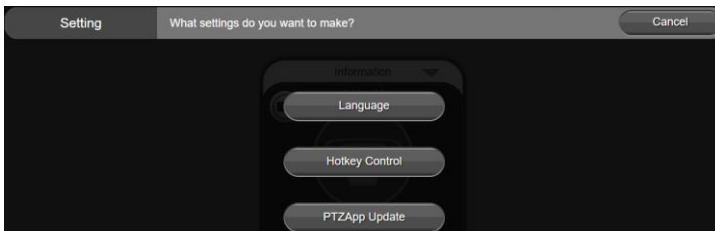
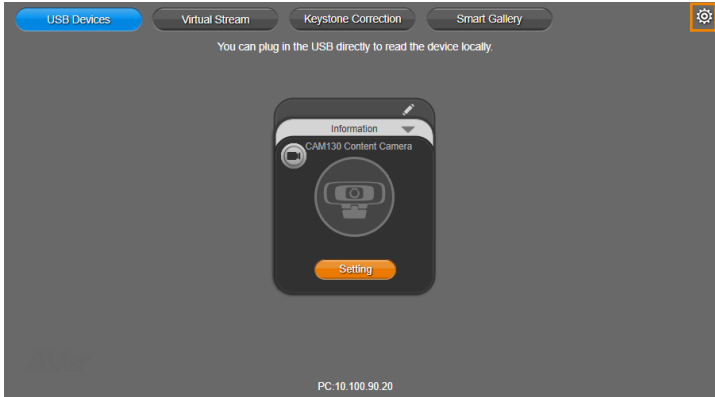

- **Language:** Select the desired language and click the check icon to confirm the selection.



- **Hotkey Control:** User can control the camera by using keyboard. This is a general list for all AVer USB Cameras. Backlight Control equals to WDR function in CAM130 Content Camera.

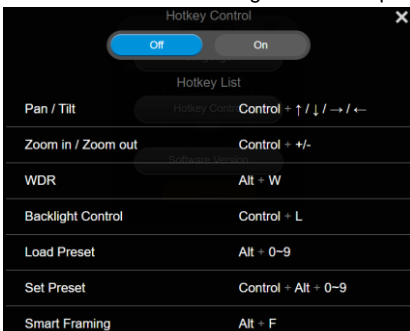

- **PTZApp Update:** Get current PTZApp 2's version number and do auto update here.





6. **Information:** Click the drop-down triangle icon to review the information of camera. To minimize the information, click the triangle or the bottom area of the information icon.



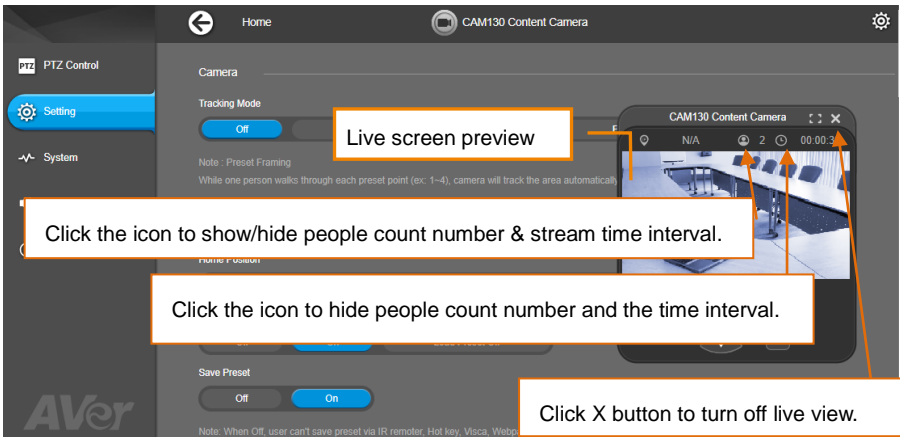
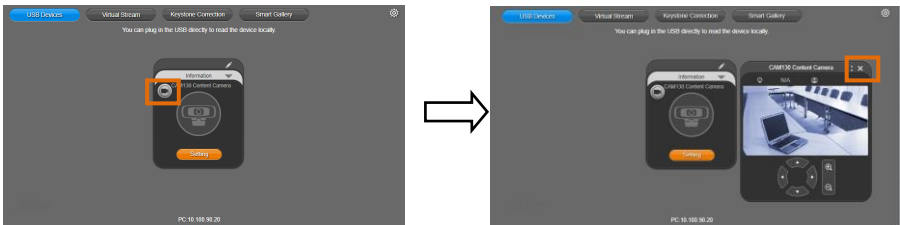

7. **Camera:** Click the camera icon to view the camera live view. Click the X icon to close the camera live view. If the live video did not appear, please check the camera and the laptop/PC connection to make sure all devices are connected properly. The resolution of this small live view is 640x480.

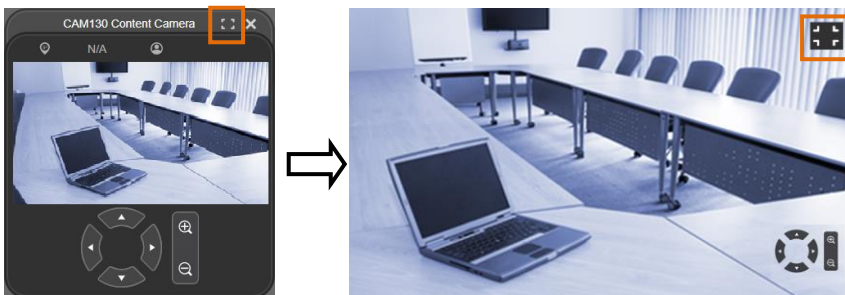

- Full Screen:** PTZApp 2 can switch to full screen mode. Click  icon and video screen will switch to full screen mode. In full screen mode, user can use direction panel to control camera direction. Click  icon to go back to normal screen view. The resolution of full screen mode is 1080p.



- People Count and Stream Interval:** Click the  icon to show people count number and stream time interval. Click the  or  icon to hide the stream time interval.

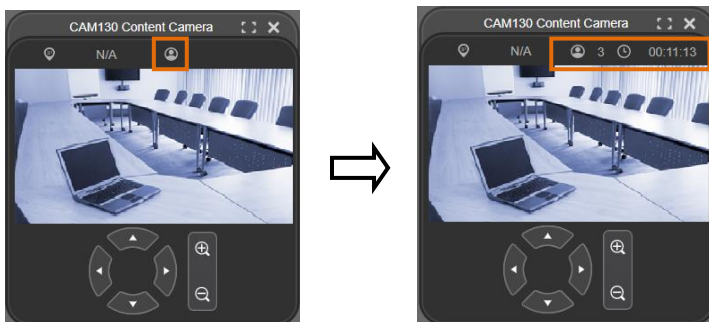

- Control Panel:** To control the camera direction, and zoom in/out.



8. **Setting:** Click “**Setting**” button to set up parameters of the camera. Click arrow icon to leave and return to Home page.

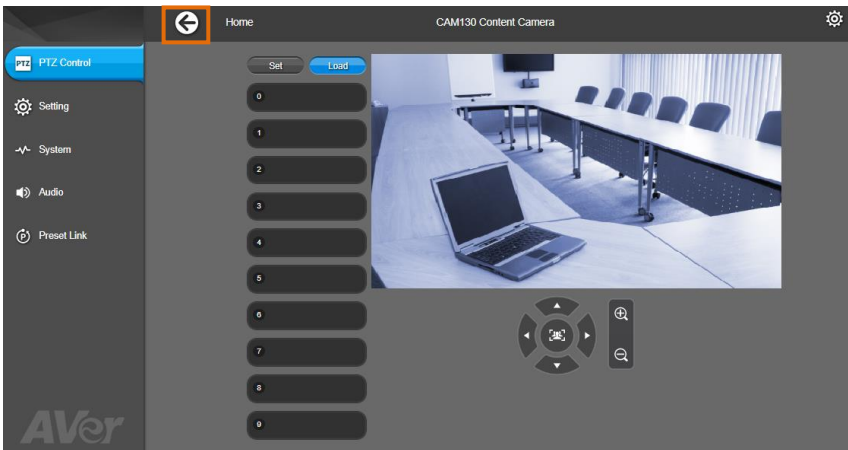

9. **PTZApp 2 Quit & Restore:** To quit the application, right-click the icon on the system tray and select “**Quit**”. If you can’t launch PTZApp 2 right after installation, please right –click the icon and choose “**Restore**”.

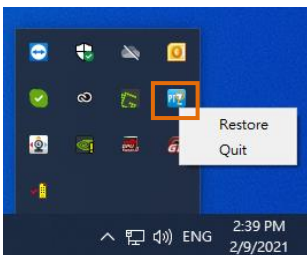

## PTZ Control

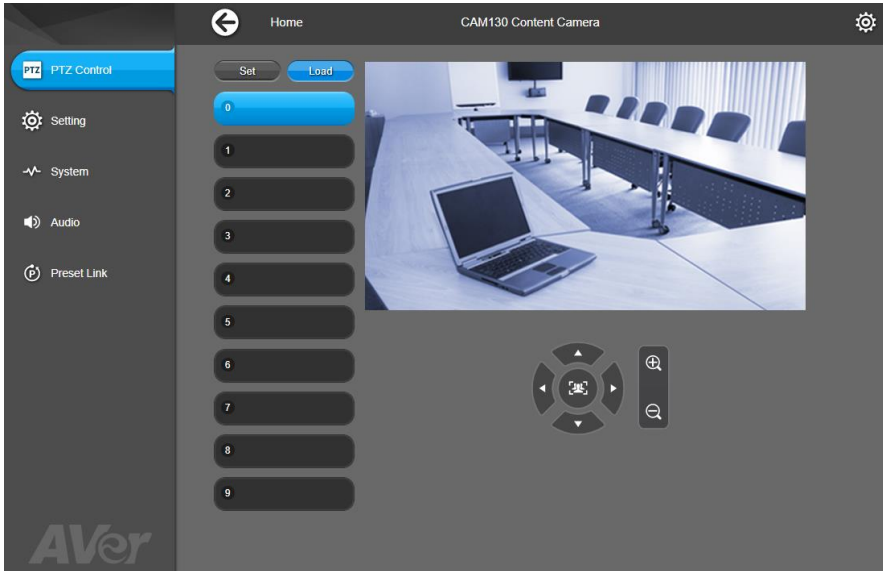

### Set Up Preset Positions

Users can set up to 10 preset positions and when clicking on the pre-configured preset numbers, the camera view will turn to the positions.

To set up preset positions:

1. Click the Set button to start the configuration.

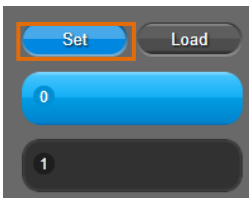

2. Use the zoom in/out buttons to have a close-up view and the ▲, ▼, ◀, ▶ buttons to adjust camera view to the desired position.
3. To apply this position to a preset number, click on a preset number, a dialog window appears. Click Yes to save this preset position.

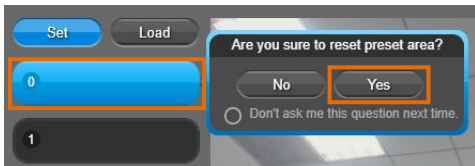

4. Follow Step 2 and Step 3 to set up more preset numbers.
5. After the set up process is complete, click the Load button to perform the Preset Position function. Click the preset number (0~9) and the camera will turn to the preset positions.

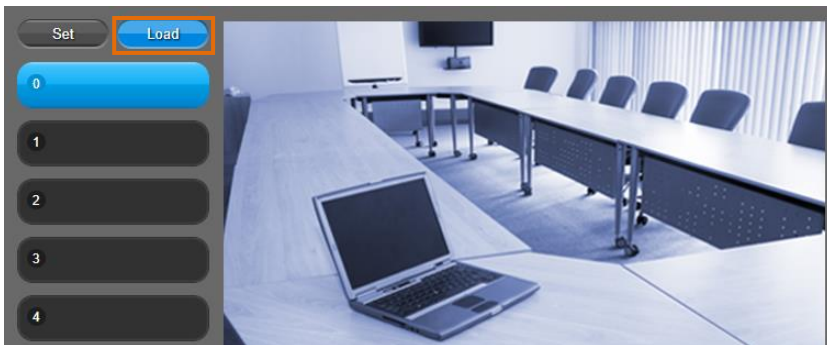

# Setting > Camera Settings

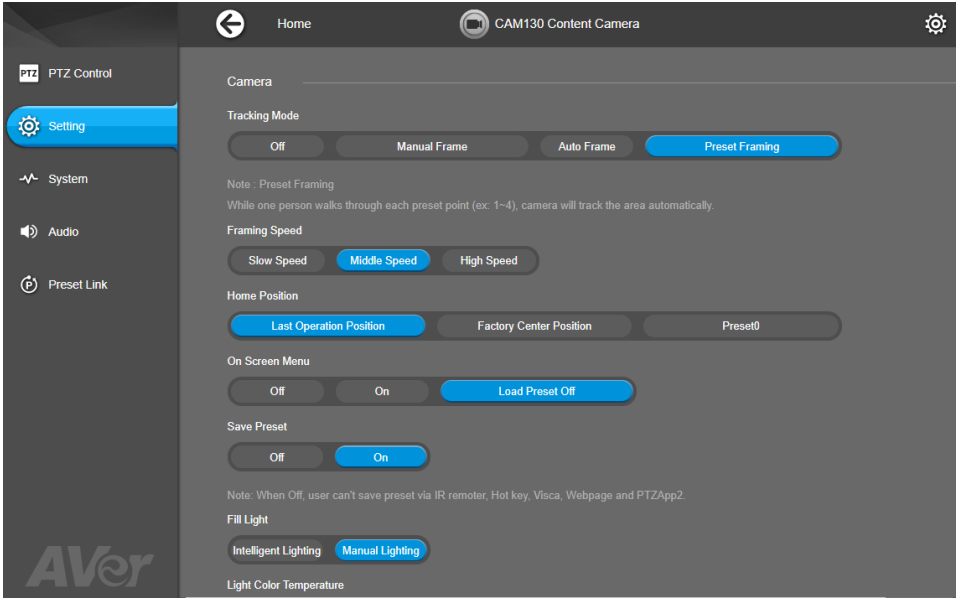

## Tracking Mode

Select **Setting > Camera > Tracking Mode > Off, Manual Frame, Auto Frame, or Preset Framing.**

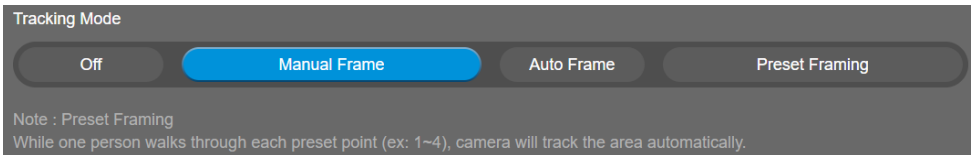

- **Off (default):** Tracking mode is disabled.
- **Manual Frame:** User one-click SmartFrame button and camera will adjust view angle to fit all participants in screen for once.
- **Auto Frame:** Camera automatically adjusts view angle to frame all participants in screen every time when it detects people’s faces or bodies. While in Auto Framing mode, an icon message (as figure shown) will display on the upper left screen to indicate in SmartFrame status. The icon will appear 2~3 sec on the screen. Once the process is done, it will disappear. If you don’t want to see the icon display, please go to PTZApp 2, find **“On Screen Menu”** function and select **“Off”**.





This action will be activated while people in the room sit or stand still for 1~5 seconds, depending on framing speed you select\*. Once all the participants are in frame, the camera will keep the image stable by not completing any action until subjects move in or out of the screen. When people touch the sides of the screen or enter the 120degree lens field of view, it will trigger the camera and automatically track, detect and frame all the participants again.

\*The default framing speed is "Middle" speed. "High" speed is more suitable for one person tracking.

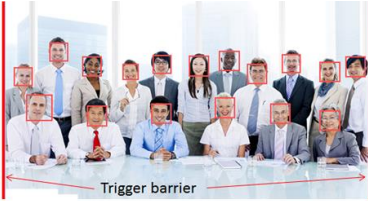

**[Note]** CAM130 Content Camera frames people in masks or any facial profile up to 5 meters away!

- Preset Framing:** Set up preset points in advance. (Only for Preset points 1~9. Preset 0 is for home position). This is designed for requiring a specific zooming area with preferred image proportion. Camera tracks and frames all the participants in the screen if none of them touch any preset area. When any of them touch a preset area, the camera will immediately shoot the preset zones instead of focusing and zooming into presenter. To keep the screen stable, whenever there is a person in the area, the camera won't move any more until no one shows up. However, the camera can detect the direction where the last person goes. If the person goes to the next preset area with overlap section, the camera will directly move to the next preset area. Thus, to ensure smooth transition, please set up zones with overlapping presets.

Overlap beginning & end of each zone



If the preset zones do not overlap and when the last person leave the preset area, camera will zoom out to wide to find people and frame them again.

If more than 2 presets areas are touched by 2 persons, camera will go to preset 1. The priority is preset 1>preset2> preset 3....>preset 9

## Framing Speed

Select **Setting > Camera > Framing Speed > Slow Speed, Middle Speed** (default), or **High Speed**.

When in auto framing or preset framing mode, camera will automatically frame people if they stand still without moving for 1~5 seconds.

- **Slow Speed:** camera starts to frame people if they don't move for 5 seconds.
- **Middle Speed:** camera starts to frame people if they don't move for 3 seconds.
- **High Speed:** camera starts to frame people if they don't move for 1 second.

[Note] High Speed is more suitable for one person tracking.

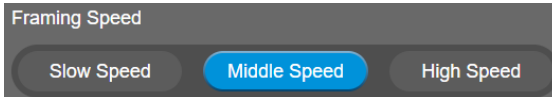

## Home Position

Every time when powering on the camera, it will turn to this position.

Select **Setting > Camera > Home Position > Last Operating Position, Factory Center Position, or Preset 0**.

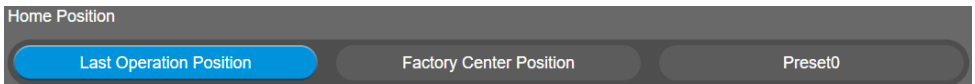

## On Screen Menu

Enable/disable on screen display status information. For instance, when it is at auto frame mode, it will appear "Auto framing" on the upper left corner of the screen. If you don't want to see the words, please select Off.

Select **Setting > Camera > On Screen Menu > Off, On, or Load Preset Off**.



## Save Preset

Enable/disable "save preset" function. In some cases, in order not to let end-users change preset points, IT guys can lock "save preset" function by switching this function off.

When it's off, user can't save preset points via IR remoter, Hot key, and PTZApp 2.

Select **Setting > Camera > Save Preset > Off or On**.

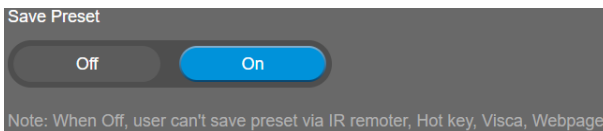

## Fill Light

Select **Setting** > **Camera** > **Fill Light** > **Intelligent Lighting** or **Manual Lighting**.

The screenshot shows the 'Fill Light' settings interface. At the top, there are two toggle buttons: 'Intelligent Lighting' (disabled) and 'Manual Lighting' (active). Below this are two sliders: 'Light Color Temperature' ranging from 2700k to 5700k, and 'Light Brightness' ranging from 1 to 12. A 'Remember User's Light Setting' section has 'No' and 'Yes' buttons, with 'Yes' selected. A note states: 'Note: When the setting is no, back to factory default after restarting the camera.' The 'Advanced Light Settings' section includes three toggle buttons: 'Turn on light when camera is power on.' (No selected), 'Turn on light when video stream is on.' (No selected), and 'Turn off light when video stream is off.' (Yes selected).

Fill Light

Intelligent Lighting  Manual Lighting

Light Color Temperature

2700k  5700k

Light Brightness

1  12

Remember User's Light Setting

No  Yes

Note: When the setting is no, back to factory default after restarting the camera.

Advanced Light Settings

Turn on light when camera is power on.

No  Yes

Turn on light when video stream is on.

No  Yes

Turn off light when video stream is off.

No  Yes

## Setting > Image Settings

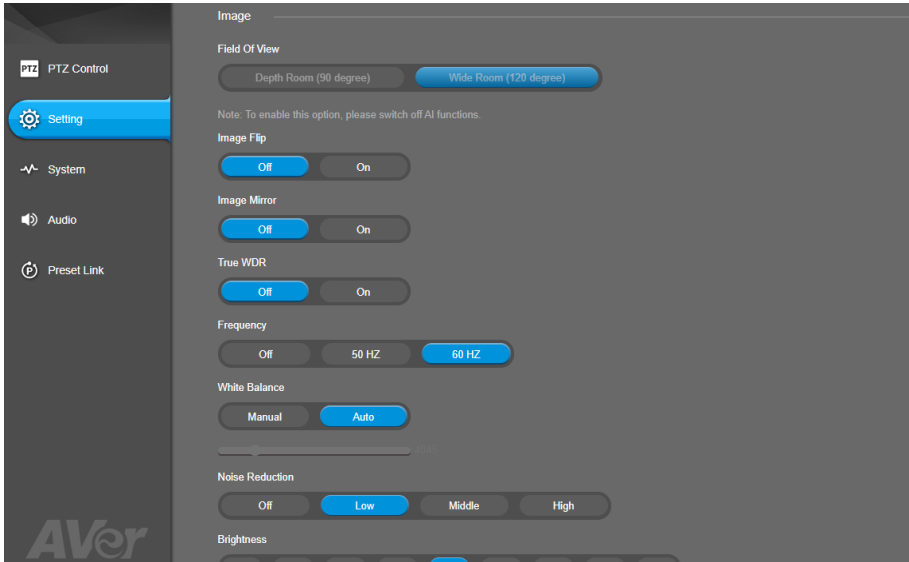

### Field of View

Two kinds of view angle to select for different types of rooms.

Select **Setting > Image > Field Of View > Depth Room (90 degree)** or **Wide Room (120 degree)**.

**[Note]** To enable this option, please switch off AI functions.

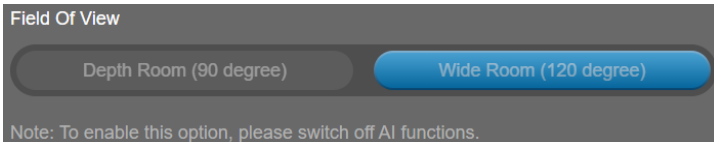

### Image Flip

If the CAM130 Content Camera is installed in the upside down position, please enable the "Flip".

Select **Setting > Image > Image Flip > Off** or **On**.



### Image Mirror

To mirror the camera image.

Select **Setting > Image > Image Mirror > Off** or **On**.



## True WDR

In back light environment, enable WDR to improve the brightness of image.

Select **Setting > Image > True WDR > Off or On.**

The frame rate will be limited to 30fps while WDR is on.

If user enables this function in a normal light condition, the image will become over exposure and encounter image blur.

When WDR is enabled, camera has taken long exposure and user cannot manually adjust the brightness of image.



## Flicker Decrease on IFP / Monitor

This is to ensure fluid content capture on IFP monitor

Select **Setting > Image > Flicker Decrease on IFP / Monitor > Off or On.**

When Flicker Decrease on IFP / Monitor is enabled, True WDR will automatically turn off. When True WDR is enabled, Flicker Decrease on IFP / Monitor will automatically turn off.

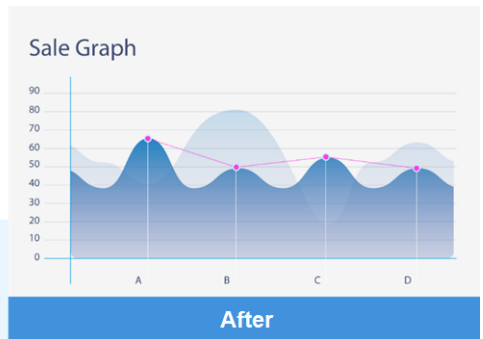
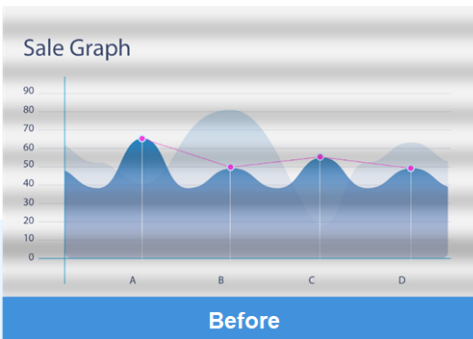
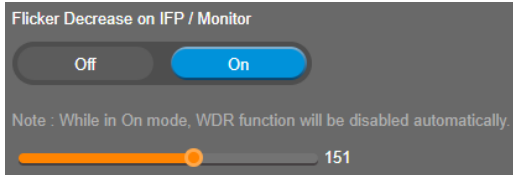

## Frequency

Select the frequency of the camera.

Select **Setting > Image > Frequency > Off, 50 HZ or 60 HZ.**

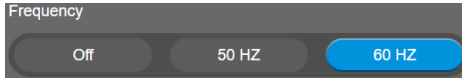

## White Balance

Select the white balance setting for various light conditions or color temperature.  
Select **Setting > Image > White Balance > Auto or Manual.**

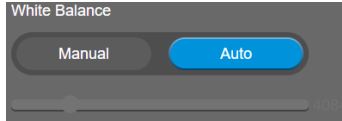

## Noise Reduction

To reduce the noise from the signal.  
Select **Setting > Image > Noise Reduction > Off, Low, Middle, or High.**



## Brightness

Adjust the value of brightness.  
Select **Setting > Image > Brightness > 1 ~ 9.**



## Sharpness

Adjust the value of sharpness.  
Select **Setting > Image > Sharpness > Off, Low, Middle, or High.**



## Saturation

Adjust the value of saturation.  
Select **Setting > Image > Saturation > 1 ~ 9.**

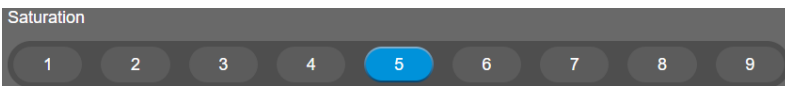

## Low Light Compensation

Select **Setting > Image > Low Light Compensation > Off** or **On**.  
Please notice that the frame rate will drop to 10~15 fps.



## Low resolution under 720p

Select **Setting > Image > Low resolution under 720p > Disable** or **Enable**.

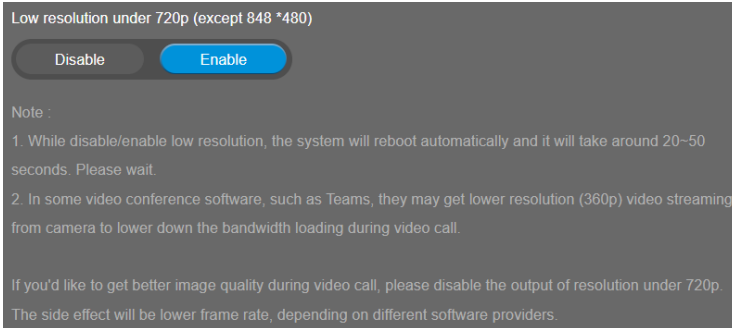

## Resolution Mode

Select **Setting > Image > Resolution Mode > Content Camera** or **Conference Camera**.

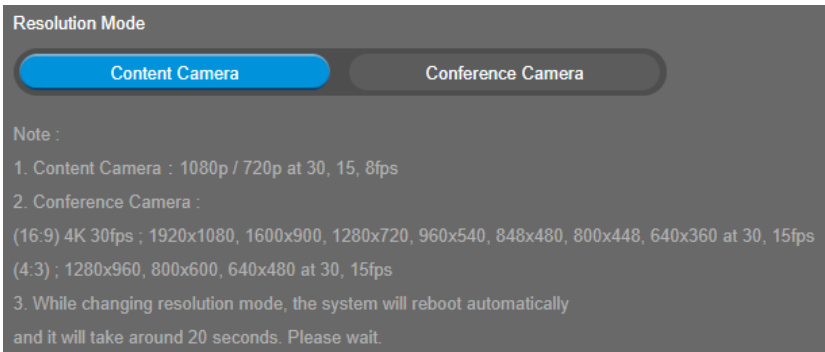

## Enlarge Total Zoom Up To 5x

Select **Setting > Image > Enlarge Total Zoom Up To 5x > Disable** or **Enable**

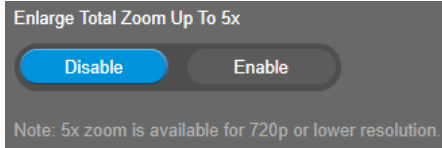

## System

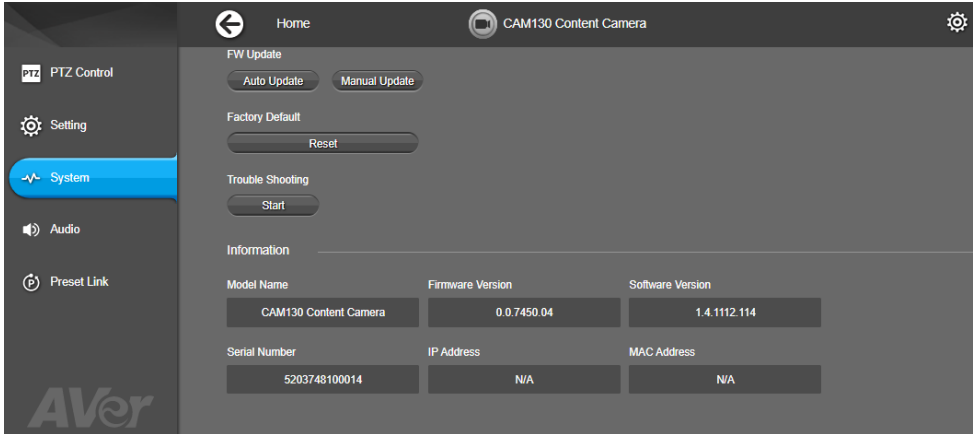

## Firmware Update

Update the camera's firmware.

Select **System** > **FW Update** > **Auto Update** or **Manual Update**.



- **Auto Update:** The system will check firmware version from AVer server and request to update.
- **Manual Update:** To update the firmware from specific location.

After updating, the camera will **reboot** and the connection will be lost. Please wait for few minutes and always keep the power cable and USB cable connected. If unplugging the power cable or USB cable during this process, it will cause damage of the device.

## Factor Default

Reset the camera back to factory default setting.

1. Select **System** > **Factory Default** > **Reset**.
2. Select **Continue** to reset back to factory default.

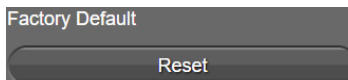



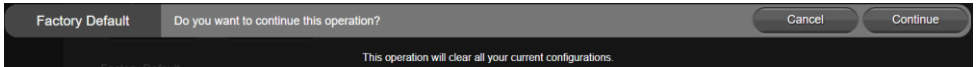

## Trouble Shooting

Output log to save in local PC.

1. Select **System > Trouble Shooting > Start**.
2. Select **Output**.

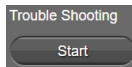

## Information

Display the information of **Model Name**, **Firmware Version**, **Serial Number**, and **MAC Address**.

Select **System > Information**.

Model Name	Firmware Version	Serial Number
CAM130 Content Camera	0.0.7450.02	000000000000
IP Address	MAC Address	
N/A	N/A	

# Audio

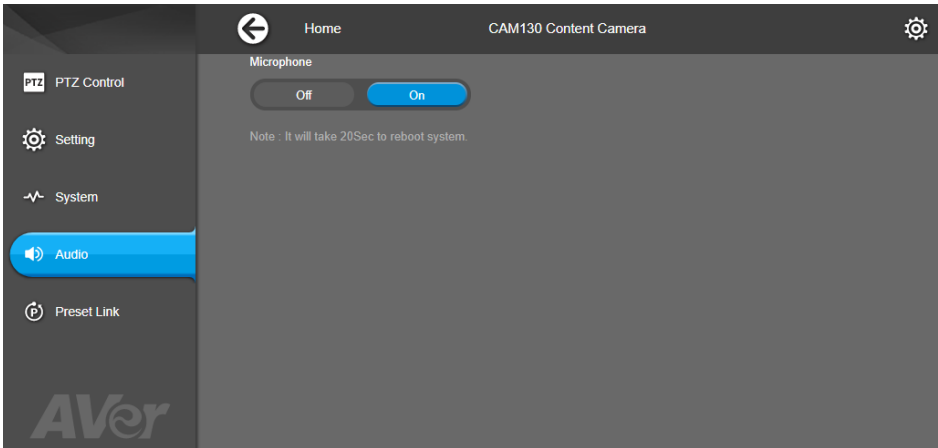

## Microphone

Enable/disable microphone function. The default setting is off.

Select **Audio > Microphone > Off or On.**

While changing the microphone status, the system requires 20 sec to reboot.

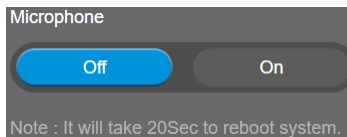

# Keystone Correction Configuration

CAM130 Content Camera is not limited to teams room system. It can also be used in all VC software. Please set up AVer keystone correction function via PTZApp 2. If AI function and keystone function are both enabled, keystone function (whiteboard/IFP capturing) will be a higher priority.



## [Notes]

1. If you are using Teams room and you want to enable AVer keystone function, please disable the Content enhancements function in Teams room to perform better keystone function.
2. The AVer Keystone Correction function only supports Windows OS.
3. While installing PTZApp2, if you refuse to install IP virtual streaming, Keystone Correction and Smart Gallery plug-in on your Windows PC (as photo below), you will not use Keystone Correction function. If you would like to enable this function, please reinstall PTZApp2.

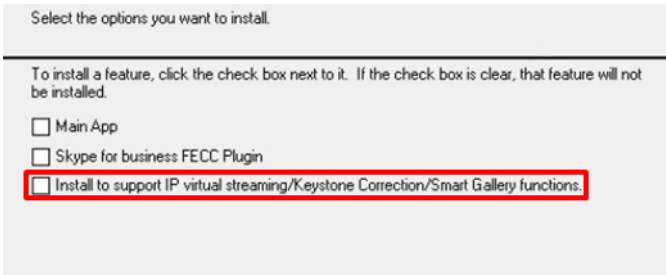

To set up the Keystone Correction function:

1. Connect your camera supported with Keystone Correction function to the computer with USB cable.
2. Launch PTZApp 2 (  ) and click **Keystone Correction**. PTZApp 2 will start searching for the camera.

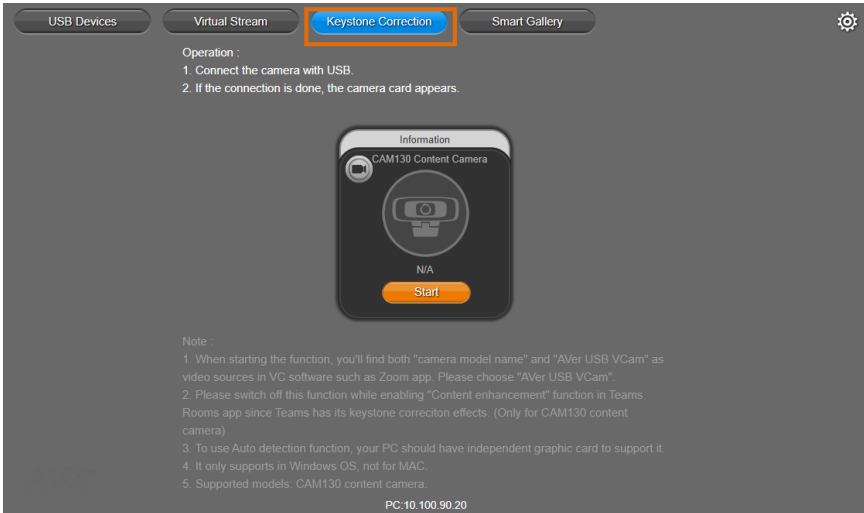

3. Launch video conference software (e.g. Zoom, Teams, Skype) and choose AVer USB VCam as the video source to start collaborating. **[Note]** You will find both "camera model name" and "AVer USB VCam" as video sources in the VC software. Please choose "AVer USB VCam".
4. Click the **Start** button, the button will change to **Stop**, and you can start configuring the Keystone Correction function. To stop the Keystone Correction configuration, click **Stop**.

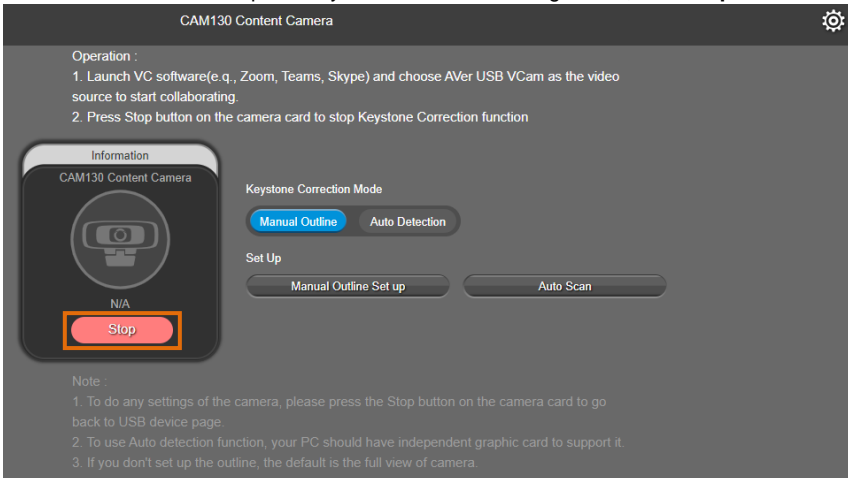

5. There are two ways to configure the Keystone Correction function, Manually or Automatically.  
To manually configure the Keystone Correction function:
  - a. Select **Manual Outline** in the **Keystone Correction Mode** field.
  - b. Click the **Manual Outline Set up** button in the **Set Up** field.
  - c. Drag the corners to define the whiteboard area. Make sure the camera captures the whole

frame within four edges of the whiteboard. Click **Next** to proceed.



- d. If you want to resize the area, click **Edit**. If the area is just fine, click **Save**.

To automatically configure the Keystone Correction function:

- a. Select **Auto Detection** in the **Keystone Correction Mode** field, the PTZApp 2 will automatically detect the graphic card driver of your computer and the Keystone Correction package. If the package is not the latest, follow the on-screen instructions to download and install the package.

**[Note]** To use the **Auto Detection** function, your computer should have independent graphic card to support it.

- b. Click **Auto Scan** in the **Set Up** field.  
c. Click **Scan**, the PTZApp 2 will automatically align the outline of the whiteboard/IFP.



- d. If you want to rescan the outline, click **Edit**. If the outline area is just fine, click **Done**.

# EZLive

Please go to <https://www.aver.com/download-center> to download the AVer EZLive software. After downloading, double-click on the file and follow the on-screen instructions to complete the installation.

## Use AVer EZLive

During a video call, EZLive can help user to do:

- (1) Camera ePTZ
- (2) Volume control for the speaker connected
- (3) Capture camera's still images
- (4) Record video
- (5) Live stream to YouTube, Livehouse.in, USTREAM, etc.
- (6) Camera Zoom in/out
- (7) Capture PC screen shot
- (8) Record PC screen video
- (9) Set up livestream
- (10) Open file management to retrieve photos and video files
- (11) Livestream setting
- (12) Drawing tool

